Compact Disc Player

CDP-NW10

DVD Player

DVP-NW50

User's Manual

WARNING

To prevent fire or shock hazard, do not expose the unit to rain or moisture.

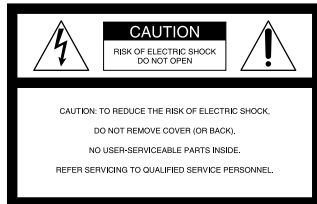

This symbol is intended to alert the user to the presence of uninsulated “dangerous voltage” within the product’s enclosure that may be of sufficient magnitude to constitute a risk of electric shock to persons.



This symbol is intended to alert the user to the presence of important operating and maintenance (servicing) instructions in the literature accompanying the appliance.

WARNING

This equipment has been tested and found to comply with the limits for a Class B digital device, pursuant to Part 15 of the FCC Rules. These limits are designed to provide reasonable protection against harmful interference in a residential installation. This equipment generates, uses, and can radiate radio frequency energy and, if not installed and used in accordance with the instructions, may cause harmful interference to radio communications. However, there is no guarantee that interference will not occur in a particular installation. If this equipment does cause harmful interference to radio or television reception, which can be determined by turning the equipment off and on, the user is encouraged to try to correct the interference by one or more of the following measures:

- Reorient or relocate the receiving antenna.
- Increase the separation between the equipment and receiver.
- Connect the equipment to an outlet on a circuit different from that to which the receiver is connected.
- Consult the dealer or an experienced radio/TV technician for help.

CAUTION

You are cautioned that any changes or modifications not expressly approved in this manual could void your authority to operate this equipment.

Note to CATV system installer:

This reminder is provided to call the CATV system installer’s attention to Article 820-40 of the NEC that provides guidelines for proper grounding and in particular, specifies that the cable ground shall be connected to the ground system of the building, as close to the point of cable entry as practical.

If you have any questions about this product, you may call;
Sony Customer Information Service Center
1-800-222-7669 or
<http://www.sony.com/>

The number below is for the FCC related matters only.

Regulatory Information

Declaration of Conformity

Trade name: SONY
Model No.: CDP-NW10/DVP-NW50
Responsible Party: Sony Electronics Inc.
Address: 16450 W. Bernardo Dr.
San Diego, CA 92127 U.S.A.
Telephone No.: 858-942-2230

This device complies with Part 15 of the FCC Rules. Operation is subject to the following two conditions:

(1) This device may not cause harmful interference, and (2) this device must accept any interference received, including interference that may cause undesired operation.

Important Safety Instruction

- 1 Read these instructions.
- 2 Keep these instructions.
- 3 Heed all warnings.
- 4 Follow all instructions.
- 5 Do not use this apparatus near water.
- 6 Clean only with dry cloth.
- 7 Do not block any ventilation openings. Install in accordance with the manufacturer’s instructions.
- 8 Do not install near any heat sources such as radiators, heat registers, stoves, or other apparatus (including amplifiers) that produce heat.

- 9 Do not defeat the safety purpose of the polarized or grounding-type plug. A polarized plug has two blades with one wider than the other. A grounding type plug has two blades and a third grounding prong. The wide blade or the third prong are provided for your safety. If the provided plug does not fit into your outlet, consult an electrician for replacement of the obsolete outlet.
- 10 Protect the power cord from being walked on or pinched particularly at plugs, convenience receptacles, and the point where they exit from the apparatus.
- 11 Only use attachments/accessories specified by the manufacturer.
- 12 Use only with the cart, stand, tripod, bracket, or table specified by manufacturer, or sold with the apparatus. When a cart is used, use caution when moving the cart/apparatus combination to avoid injury from tip-over. 
- 13 Unplug this apparatus during lightning storms or when unused for long periods of time.
- 14 Refer all servicing to qualified service personnel. Servicing is required when the apparatus has been damaged in any way, such as power-supply cord or plug is damaged, liquid has been spilled or objects have fallen into the apparatus, the apparatus has been exposed to rain or moisture, does not operate normally, or has been dropped.

Welcome!

Thank you for purchasing the Sony Custom Integrated AV System. Before operating the unit, please read this manual thoroughly and retain it for future reference.

TABLE OF CONTENTS

About This Manual	5
Notes About the Discs	5
Features	6
Quick Guide to Disc Type	8

Chapter 1 Getting Started

Setting up the System	10
Connecting a TV (DVP-NW50 only)	10
Connecting audio Equipment	10
Selecting a method for using the remote	11
Setting up the Units	11
Setting an IP Address	11
Naming the Unit	12
Setting the time	13
Setting a remote code on the Unit	13
Selecting the time interval for automatic return to the Home Menu	13

Chapter 2 Parts and Controls

Parts and Controls	14
Key operation on the Unit	15
Key operation on the remote	16
Preparing the remote	18
Setting a remote code on the remote	18
Menu operation	18
Menu tree	19

Chapter 3 Playing Discs (CDP-NW10 only)

Playing a CD Disc	20
Various play mode functions (Shuffle play, Repeat play)	21
Searching for a particular point on a disc (Search/Scan)	21

Chapter 4 Playing Discs (DVP-NW50 only)

Playing a CD Disc	22
Various play mode functions (Shuffle play, Repeat play)	23
Playing a DVD/VCD/MP3 Disc	23
Using the DVD's menu	24
Playing VIDEO CDs with PBC functions (VIDEO CD Ver. 2.0 or higher)	24
Playing an MP3 audio track	25
Searching for a Scene	25
Searching for a particular point on a disc (Search/Scan)	25
Searching for a title/chapter/track/scene, etc. (Search mode)	25
Using Various Additional Functions	26
Selecting the audio	26
Selecting the subtitles	26
Selecting the angle	26
Parental control (limited playback)	27
Using the Setup Display (DVD Settings)	28
Setting the display (General Setup)	28
Setting the language and playback restriction (Preference)	29

TABLE OF CONTENTS (continued)

Chapter 5 Enjoying Radio and Other Component

- Listening to the Radio 31
 - Listening to a preset station 31
 - Listening to a non-preset station 31
 - Presetting Radio Stations 33
 - Naming the Preset Stations 33
 - Listening to Sound from a Component Connected to LINE IN 34
-

Chapter 6 Using the System Network

- Playing Music on Other Units 35
 - Playing back music from “NETWORK” 35
 - Playing back music from “MY MUSIC” 36
 - Various play mode functions (Shuffle play, Repeat play) 36
 - Enjoying Music in All Rooms Simultaneously (Party mode) 37
 - Excluding the Unit from a Party mode (Party Privacy) 37
 - Talking with Persons in Other Rooms (INTERCOM) 38
 - Excluding a Unit from INTERCOM (Intercom Privacy) 38
 - Changing the call sound of the INTERCOM 38
 - Monitoring Other Rooms (MONITOR) 39
 - Excluding a Unit from MONITOR (Monitor Privacy) 39
-

Chapter 7 Setting the Timer

- Setting the Alarm 40
 - Setting the Sleep Timer 41
-

Chapter 8 Other Functions

- Using the Setup Display 42
 - Selecting the surround mode (DVP-NW50 only) 42
 - Adjusting the contrast of the front panel display (DIMMER) 43
 - Presetting the volume when the power is turned on (VOL PRESET) 43
 - Adjusting the front speaker balance (BALANCE) (CDP-NW10 only) 43
 - Settings for Speakers (DVP-NW50 only) 44
 - Selecting a speaker size 44
 - Setting the speaker distance 45
 - Setting a speaker level 45
 - Adjusting the speaker volume – TEST TONE 46
 - Setting the dynamic range compressor 46
 - Operating a Sony TV with the Remote 47
 - Controlling your TV with the remote 47
-

Chapter 9 Other Information

- Precautions 48
- Troubleshooting 49
- Error Messages 53
- Specifications 54
- Language Code List 55
- Index 56

About This Manual

- Some operations and displays may differ slightly, depending on the model you use.
- “DVD” may be used as a general term for DVD VIDEOS, DVD+RWs/DVD+Rs and DVD-RWs/DVD-Rs.
- The meaning of the icons used in this manual is described below:

Icon	Meaning
DVD-V	Functions available for DVD VIDEOS and DVD+RWs/DVD+Rs or DVD-RWs/DVD-Rs in video mode.
VCD	Functions available for VIDEO CDs (including Super VCDs or CD-Rs/CD-RWs in video CD format or Super VCD format encoding).
CD	Functions available for music CDs or CD-Rs/CD-RWs in music CD format.
DATA CD	Functions available for DATA CDs (CD-ROMs/CD-Rs/CD-RWs containing MP3* audio tracks).

* MP3 (MPEG1 Audio Layer 3) is a standard format defined by ISO (International Organization for Standardization)/MPEG which compresses audio data.

Notes About the Discs

To keep the disc clean, handle the disc by its edge. Do not touch the surface.

- Do not expose the disc to direct sunlight or heat sources such as hot air ducts, or leave it in a car parked in direct sunlight as the temperature may rise considerably inside the car.



- After playing, store the disc in its case.
- Clean the disc with a cleaning cloth. Wipe the disc from the center out.



- Do not use solvents such as benzene, thinner, commercially available cleaners, or anti-static spray intended for vinyl LPs.
- If you have printed the disc's label, dry the label before playing.

Features

The CDP-NW10/DVP-NW50 (referred to as the Unit in this manual) is a home audio component system based on network connections. A Unit is installed into the wall of a room and connected to other Units using an Ethernet connection (100Base-TX.)

The system consists of:

- Up to 12 Units (CDP-NW10 or DVP-NW50)
- A personal computer (if necessary)
- Audio output components, such as a CD Changer
- A monitor or a projector (DVP-NW50)
- Two speakers (2CH) (CDP-NW10)/Five speakers and a sub woofer (5.1CH) (DVP-NW50)

The main features of the Unit are the following:

- Two types of conventional CD player model and a DVD player model with a simple timer clock and 2ch audio input
- The Unit can play back MP3-format audio files stored on a computer via a network (An exclusive application of PC is needed)
- The Unit can play back CDs mounted in other Units via a network
- The Unit can play back the audio contents in all the rooms simultaneously from the following sources (Party mode)
 - CDs in any Units
 - MP3 discs (DVP-NW50 only) and LINE IN in the lead operating Unit
 - FM or AM tuner
 - MP3-format audio files stored on a computer (a Playlist feature in the Unit is available)
- INTERCOM and MONITOR functions via a network
- 2ch to 5.1ch sound produced from connected speakers for DVP-NW50, or 2ch sound produced from connected speakers for CDP-NW10

Trademarks and Copyrights

This product incorporates copyright protection technology that is protected by U.S. patents and other intellectual property rights. Use of this copyright protection technology must be authorized by Macrovision, and is intended for home and other limited viewing uses only unless otherwise authorized by Macrovision. Reverse engineering or disassembly is prohibited.

This Unit incorporates Dolby* Digital and Pro Logic surround and the DTS** Digital Surround System.

* Manufactured under license from Dolby Laboratories. "Dolby," "Pro Logic," and the double-D symbol are trademarks of Dolby Laboratories.

** Manufactured under licence from Digital Theater System, Inc. "DTS" and "DTS Digital Surround" are registered trademarks of Digital Theater System, Inc.

Gracenote/CDDB

Corporate description

Music recognition technology and related data are provided by Gracenote®. Gracenote is the industry standard in music recognition technology and related content delivery. For more information visit www.gracenote.com.

Proprietary legends

CD and music-related data from Gracenote, Inc., copyright © 2000-2005 Gracenote. Gracenote CDDB® Client Software, copyright 2000-2005 Gracenote. This product and service may practice one or more of the following U.S. Patents: #5,987,525; #6,061,680; #6,154,773, #6,161,132, #6,230,192, #6,230,207, #6,240,459, #6,330,593, and other patents issued or pending. Services supplied and/or device manufactured under license for following Open Globe, Inc. United States Patent 6,304,523.

Gracenote and CDDB are registered trademarks of Gracenote. The Gracenote logo and logotype, and the "Powered by Gracenote" logo are trademarks of Gracenote.



CDP-NW10/DVP-NW50 system network

The diagram below illustrates an entire system network made up of multiple Units.
The configuration shown below is for illustrative purposes only. It may differ from an actual system network.
Contact your nearest installer for details on making the required connections for the system network.

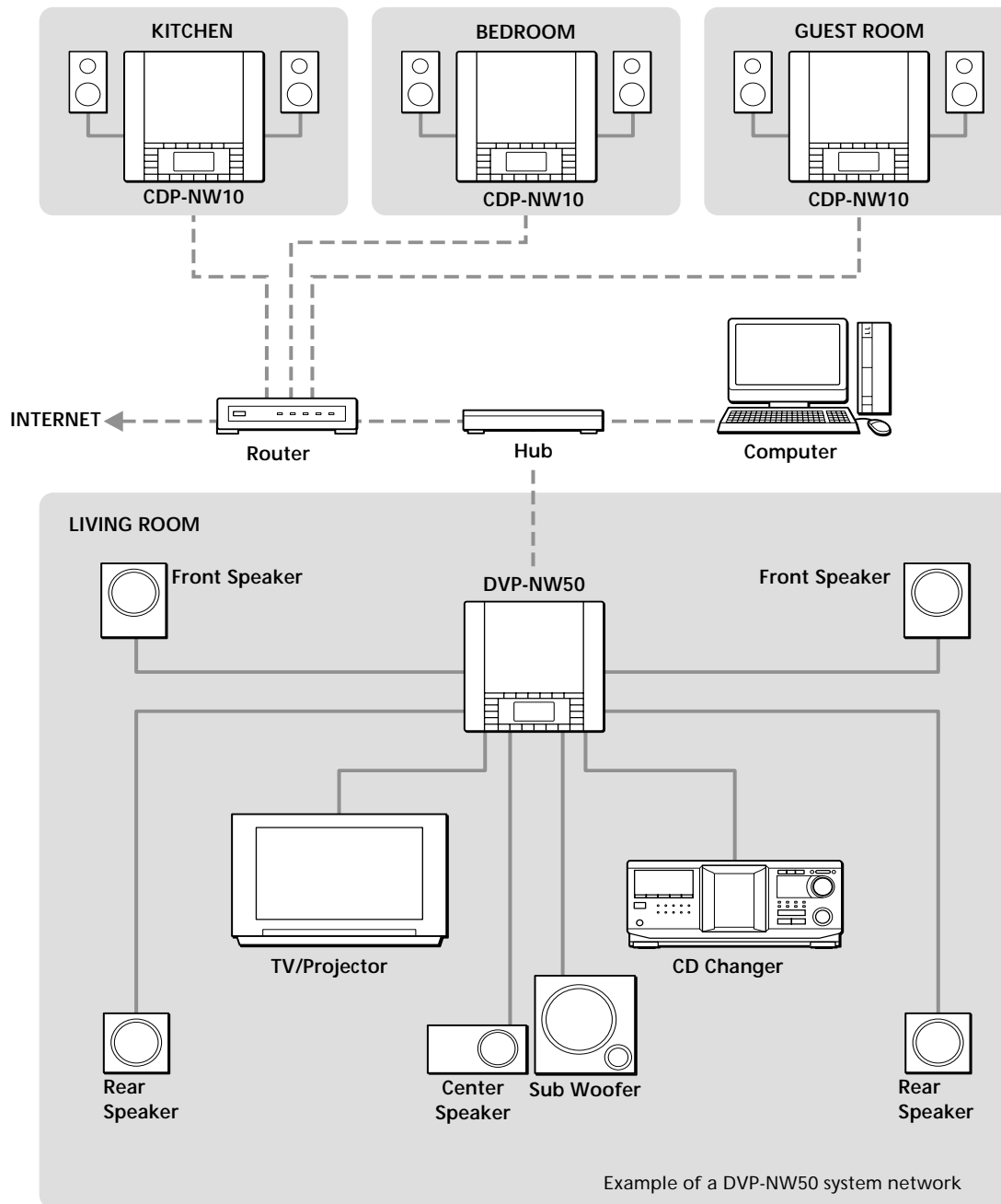

Quick Guide to Disc Type

Discs that can be played back on the Unit differ, depending on the model you are using. The kinds of disc that you can use on the Unit are as follows.

CDP-NW10

Format of discs

Music CD 

CD-R 

CD-RW 

Also, the Unit can play CD-Rs/CD-RWs recorded in the following format:

- Music CD format
- CD Extra format*

* Only a music session can be played back.

The kinds of disc that cannot be played back

- CD-Rs/CD-RWs other than those recorded in the formats listed above
- CD-ROM
- Data part of CD-Extras
- VIDEO CD
- DVD+R/DVD-R/DVD-RW/DVD+RW
- DVD-ROM
- DVD Audio
- MP3 format
- Super Audio CD

DVP-NW50

Format of discs

DVD VIDEO 

DVD-R 

DVD-RW 

VIDEO CD 

Music CD 

CD-R 

CD-RW 

The “DVD VIDEO” logo, the “DVD-R” and the “DVD-RW” logo are trademarks.

Also, the Unit can play CD-Rs/CD-RWs recorded in the following formats:

- Music CD format
- CD Extra format*
- VIDEO CD format
- MP3 format conforming to ISO 9660* Level 1/Level 2, or its extended format, Joliet

* A logical format or files and folder on CD-ROMs, defined by ISO (International Organization for Standardization)

The kinds of disc that cannot be played back

- CD-Rs/CD-RWs other than those recorded in the formats listed above
- CD-ROM recorded in PHOTO CD format
- Data part of CD-Extras
- DVD-ROM
- DVD Audio
- Super Audio CD
- DVD VIDEO with a different region code
- DVD-R/DVD-RW's inVR (Video Recording) mode
- DVD+R/DVD-R of double layer disc

Example of discs that the Unit cannot play

The Unit cannot play the following discs:

- A disc that has a non-standard shape (e.g., card, heart)
- A disc with paper or stickers on it
- A disc that has the adhesive of cellophane tape or a sticker still left on it.

Note about CD-R/CD-RW/DVD-R/DVD-RW (Video mode)/DVD+R/DVD+RW

In some cases, CD-R/CD-RW/DVD-R/DVD-RW (Video mode)/DVD+R/DVD+RW cannot be played on the Unit due to the recording quality or physical condition of the disc, or the characteristics of the recording device and authoring software.

The disc will not play if it has not been correctly finalized. For more information, see the operating instructions of the recording device.

Note that discs created in the Packet Write format cannot be played.

Music discs encoded with copyright protection technologies

This product is designed to play back discs that conform to the Compact Disc (CD) standard.

Recently, various music discs encoded with copyright protection technologies are marketed by some record companies. Please be aware that among those discs, there are some that do not conform to the CD standard and may not be playable by this product.

Note on DualDisc

A DualDisc is a two sided disc product which mates DVD recorded material on one side with digital audio material on the other side.

However, since the audio material side does not conform to the Compact Disc (CD) standard, playback on this product is not guaranteed.

Note on playback operations of DVDs and VIDEO CDs

Some playback operations of DVDs and VIDEO CDs may be intentionally set by software producers. Since this Unit plays DVDs and VIDEO CDs according to the disc contents the software producers designed, some playback features may not be available. Also, refer to the instructions supplied with the DVDs or VIDEO CDs.

Region code

This Unit is designed and manufactured to respond to the Region Management information that is recorded on a DVD VIDEO. The region code of this Unit is "1."

This Unit will play DVD VIDEO labelled  or 

If you try to play any other DVD VIDEO, the message "wrong region" will appear on the TV screen. Depending on the DVD VIDEO, there may be no region code indication, even though playing the DVD VIDEO is prohibited by area restrictions.

Chapter 1 Getting Started

This chapter provides you with information how to connect and setup the Unit.

Setting up the System

Your system has already been installed by an installer. If you want to change the configuration, the TV or the audio equipment, check the location of the VIDEO out jack, the LINE IN jack, and the IR IN/OUT jack. Contact your nearest installer for details on the connections required by the system.

Connecting a TV (DVP-NW50 only)

Connections between the Unit and each device are made via cables or cords coming through the wall.

Connect the VIDEO OUT of the Unit to a TV.

Select one of the ways of connection methods shown below, according to the input jack on your TV.

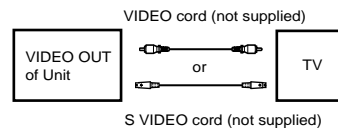

Note

Do not connect a VCR, etc., between your TV and the Unit. If you pass the Unit signals via the VCR, you may not receive a clear image on the TV screen. If your TV has only one video input jack, connect the Unit to this jack.

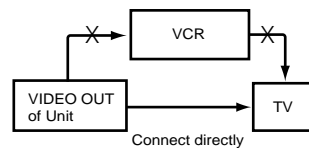

Connecting audio Equipment

Connections between the Unit and each of devices are made via cables or cords coming through the wall.

The Unit can input sound from external audio equipment via the audio connectors on the Unit. Connect the OUTPUT jacks (L/R) of the audio equipment to the LINE IN (L/R) jacks of the Unit using the proper audio cords (optional).



Selecting a method for using the remote

Connections between the Unit and each device are made via cables or cords coming through the wall.

You can operate a component using the remote if the IR IN/OUT terminal of the Unit and the component are connected. For example, if you connect IR IN of the Unit and IR OUT of a TV, you can operate the Unit with the Remote by aiming it at the TV.

- 1 Press the "▼" SELECT on the HOME Menu, then press the "SETUP" SELECT.
The Setup Menu appears.



- 2 Press the "▼" SELECT repeatedly until "IR ROUTE" appears on the front panel display.
- 3 Press the "IR ROUTE" SELECT.
The IR route setup Menu appears.
- 4 Select a method for using the remote.
The default setting is underlined.

Method	Operates
EYE	The Unit directly from the remote.
JACK	The Unit through the IR IN jack using signals from the remote.
<u>Both</u>	The Unit directly and through the IR IN jack using signals from the remote.

Setting up the Units

Contact your nearest installer for details on the default setting for each parameters.

For details on how to make a selection in the Menu, see page 18.

Setting an IP Address

There are two ways to acquire an IP address. The default setting is underlined.

- AUTO: You can acquire the IP address automatically.
Normally, select this setting.
- MANUAL: You can set up the IP address manually.
Because some knowledge of networking is required to use this setting, we recommend you normally to select "AUTO."

- 1 Press the "▼" SELECT on the HOME Menu, then press the "SETUP" SELECT.
The Setup Menu appears.

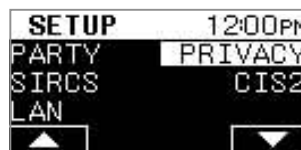

- 2 Press the "▼" SELECT repeatedly until "LAN" appears on the front panel display.
- 3 Press the "LAN" SELECT.
The LAN setup Menu appears.

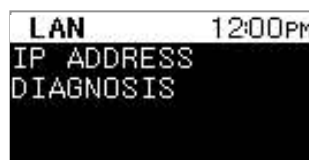

- 4 Press the "IP ADDRESS" SELECT.
The IP address setup Menu appears.

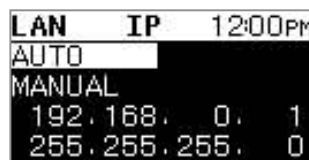

Continue to the next page ➞

Setting up the Units (continued)

5 Press "AUTO" or "MANUAL" SELECT.

If you select "AUTO," setting an IP address is completed.

If you select "MANUAL," go to the step 6.

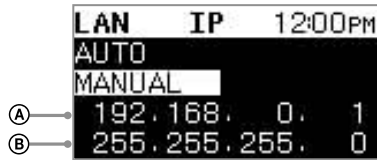

6 Press the (A) SELECT to set an IP address.

">" appears, and the first three numbers can be entered.

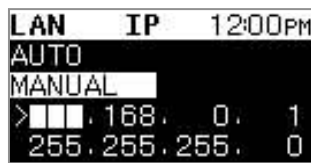

7 Enter the IP address using numeric buttons on the remote, then press ENTER.

8 Press the (B) SELECT to set a Sub-net mask.

">" appears, and the first three numbers can be entered.

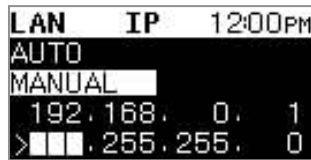

9 Enter the Sub-net mask using numeric buttons on the remote, then press ENTER.

10 Press BACK.

The display returns to the LAN setup Menu.

11 Press the "DIAGNOSIS" SELECT.

The confirmation display appears.

Confirm the following items.

IP Assign

OK IP address is assigned correctly.

NG Illegal address has been assigned.

IP Conflict

OK IP address has no conflict.

NG Two or more Units are using the same IP address.

Cable Connect

OK Ethernet cable is inserted correctly.

NG Ethernet cable is not inserted correctly.

Naming the Unit

You can change the name of each room to something more recognizable and have it displayed on the front panel display.

1 Press the "▼" SELECT on the HOME Menu, then press the "SETUP" SELECT.

The Setup Menu appears.

2 Press the "▼" SELECT repeatedly until "NAME" appears on the front panel display.

3 Press the "NAME" SELECT.

The Room name list appears.



4 Press the "KITCHEN," "BEDROOM," "DEN," or "PATIO" SELECT that you want to change the name by pressing the corresponding SELECT.

5 If you want to name the room as you like, press the "EDIT" SELECT.

The Text edit setup Menu appears.

Enter the name in the text box using the function SELECT.

See the table below for details on the function of each of the buttons.



(A) Moves the cursor to the left in the text being edited (Text Edit).

(B) Changes characters in reverse alphabetical order.

(C) Clears the character on which the cursor is placed in the text being edited (Text Edit).

(D) Cancels editing and returns to the Room name list.

(E) Moves the cursor to the right in the text being edited (Text Edit).

(F) Changes characters in alphabetical order.

(G) Enters the selected character into the text box.

(H) Stores the name and returns to the Room name list.

Tip

You can input up to eight characters for the name of each room.

Setting the time

You must set the time to make functions available, such as an alarm or a sleep timer. Display the Home Menu as shown below beforehand (see page 18).



- 1 Press the "▼" SELECT on the HOME Menu, then press the "CLOCK" SELECT. The Clock Menu appears.



- 2 Press the "TIME SET" SELECT. The Time set Menu appears.

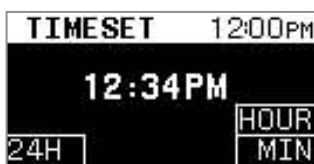

- 3 Press the "24H" (or the "12H") SELECT on the Time set Menu to select the time display mode. The time display mode toggles between 24H and 12H as you press the button.
- 4 Set the hour and minute using the "HOUR" and the "MIN" SELECT.
- 5 Press HOME to return to Home Menu. The time is displayed on the right side of the upper line on the HOME Menu.

Note

The clock is not displayed when the Unit is in the Edit Menu or Party mode.

Setting a remote code on the Unit

If the supplied remote interferes with an other, set the remote code for this Unit and the remote to one that differs from the other Unit.

The default remote code setting for the Unit and the supplied remote is CIS2.

- 1 Press the "▼" SELECT on the HOME Menu, then press the "SETUP" SELECT. The Setup Menu appears.

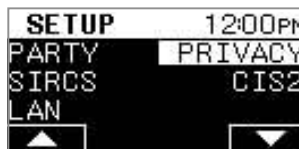

- 2 Press the "▼" SELECT repeatedly until "SIRCS" appears on the front panel display.
- 3 Press the "SIRCS" SELECT.
- 4 Press the "CIS2" (or "CIS3") SELECT. The remote code is set to the same one used by RM SETUP on the remote.

Note

You cannot operate the Unit using the remote when the remote code of the Unit and the remote are different.

Selecting the time interval for automatic return to the Home Menu

The front panel display automatically returns to the Home Menu when the selected time has elapsed.

The default time setting for the Unit is 30 seconds.

- 1 Press the "▼" SELECT on the HOME Menu, then press the "SETUP" SELECT. The Setup Menu appears.

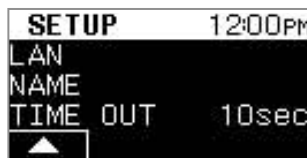

- 2 Press the "▼" SELECT repeatedly until "TIME OUT" appears on the front panel display.
- 3 Press the "TIME OUT" SELECT.
- 4 Press the "30sec," "5sec," "10sec," or "No" SELECT.

Note

If you select "No," the front panel display does not return to the Home Menu automatically.

Chapter 2

Parts and Controls

This chapter provides you with information on the parts and controls of each component, and information on menu operation.

Parts and Controls

Key operation on the Unit

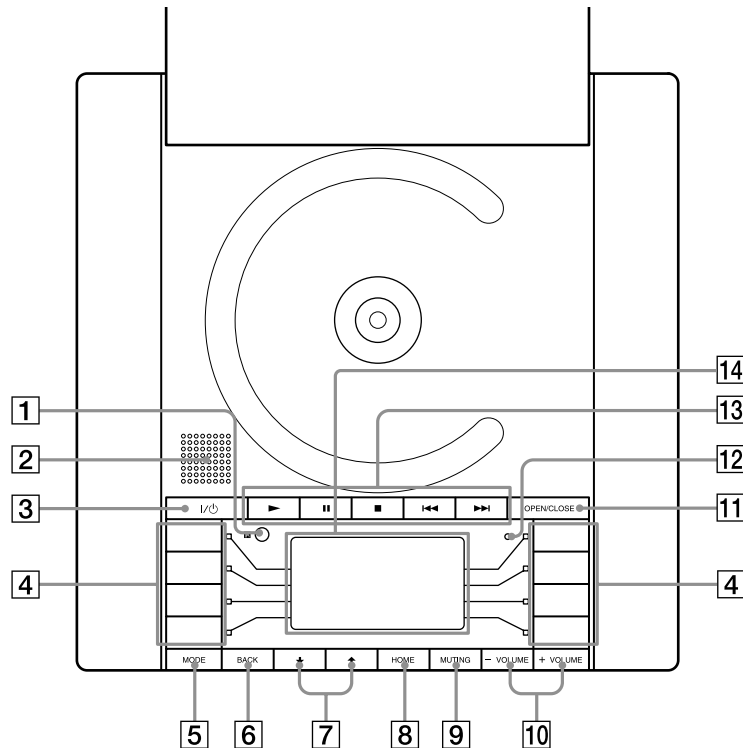

- 1 REMOTE SENSOR**
- 2 SPEAKER (for INTERCOM/MONITOR) (page 38, 39)**
Receives the sound while INTERCOM or MONITOR is set to ON.
- 3 I/⏻ (POWER) (page 20, 22, 23)**
Press to turn the power on/off.
- 4 SELECT (page 18)**
Press to select an item on the front panel display, such as menu items, settings, tracks, etc.
- 5 MODE**
Press to jump to the Mode Menu of each function.
- 6 BACK (page 12, 42)**
Press to return to the previous menu or to view the current status of the disc title list or the Preset station list.
- 7 ↓/↑ (SCROLL DOWN/UP)**
Press to scroll the LCD menu.
When you listen to the radio, you can adjust the frequency by all kinds of tuning.
- 8 HOME**
Press to return to the Home Menu.
- 9 MUTING (page 20, 22)**
Press to mute the speaker output from the Unit, or to cancel muting when it is set to ON.
- 10 +/- VOLUME (page 38, 39)**
Press to adjust the volume of the speaker output from the Unit.
- 11 OPEN/CLOSE (page 20, 22, 23)**
Press to open/close the door on the Unit.
- 12 MICROPHONE**
Picks up the sound while INTERCOM is set to ON.
- 13 OPERATIONAL BUTTONS (page 20, 22, 23)**
▶ (PLAY): Press to play the selected source
⏸ (PAUSE): Press to pause playback
■ (STOP): Press to stop playback
⏮/⏭: Locates a specific track
- 14 Display (page 18)**
Displays the Home Menu and the Setup Menu, etc. You can operate the Home Menu and the Setup Menu, etc., using any SELECT (4).

Continue to the next page ➞

Key operation on the remote

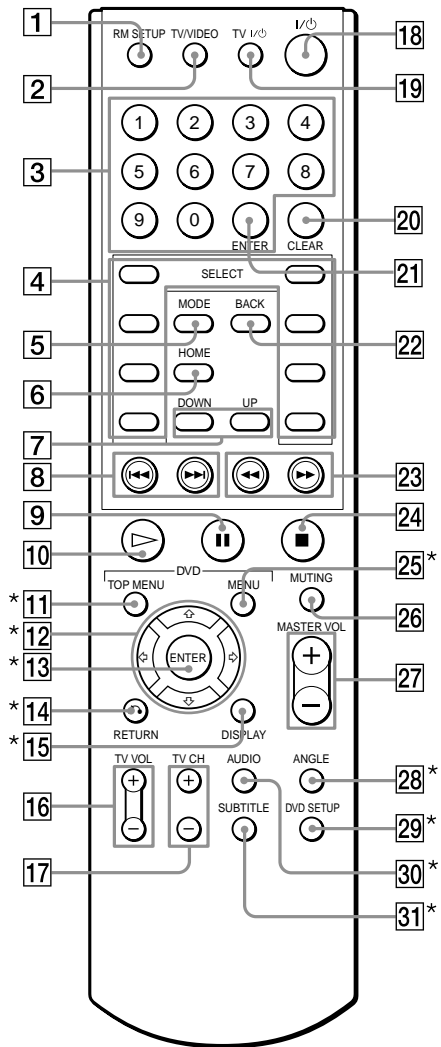

- 1 RM SETUP (page 18)**
Press to preset the remote code, and switch between CIS2/CIS3.
- 2 TV/VIDEO (page 47)**
Press to switch signals between TV input and Video input for the Sony TV monitor.
- 3 Numeral buttons**
Press to select a number, representing, for example, a desired track of the audio source.
- 4 SELECT (page 18)**
Press to select an item on the front panel display, such as menu items, settings, tracks, etc.
- 5 MODE**
Press to jump to Mode Menu of each function.
- 6 HOME**
Press to return to the Home Menu on the display.
- 7 DOWN/UP**
Press to scroll the LCD menu.
When you listen to the radio, you can adjust the frequency by all kinds of tuning.
- 8 ◀◀/▶▶ (page 21, 25)**
Press to locate a specific track of the source or to select a preset station.
- 9 || (PAUSE)**
Press to pause the playback of the source.
- 10 ▷ (PLAY) (page 20, 22, 23)**
Press to operate the selected source.
▷ (PLAY) button has a tactile dot.**
- 11 TOP MENU* (page 24)**
Press to display the top menu while using DVP-NW50.
- 12 ↶/↷/↸/↹***
Press to select a DVD setup menu on the TV screen.
- 13 ENTER***
Press to confirm the selection while using DVP-NW50.
- 14 RETURN***
Press to return to the specified position defined by DVD or VIDEO CD.
- 15 DISPLAY* (page 26)**
Press to display a search menu.
- 16 TV VOL +/- (page 47)**
Press to adjust the Sony TV volume.
TV VOL + button has a tactile dot.**
- 17 TV CH +/- (page 47)**
Press to change the Sony TV channel.
TV CH + button has a tactile dot.**
- 18 I/⏻ (page 20, 22, 23)**
Press to turn the Unit on/off.
- 19 TV I/⏻ (page 47)**
Press to turn the Sony TV on/off.
- 20 CLEAR**
Press to clear a number which you entered.
- 21 ENTER**
Press to set the number you entered using the numeric buttons.
- 22 BACK (page 12, 42)**
Press to return to the previous menu or to view the current status of the disc title list or the Preset station list.
- 23 ◀◀/▶▶ (page 21, 25)**
Press to locate a portion you want to play within a track of the source.
- 24 ■ (STOP) (page 20, 22, 23)**
Press to stop the current playback.
- 25 MENU* (page 24)**
Press to display a menu while using DVP-NW50.
- 26 MUTING (page 20, 22)**
Press to mute the speaker output from the Unit on/off.
- 27 MASTER VOL +/-**
Press to adjust the volume of the speaker output from the Unit.
MASTER VOL + button has a tactile dot.**
- 28 ANGLE (page 26)***
Press to change the viewing angle.
- 29 DVD SETUP (page 27, 28, 29, 30)***
Press to display the Setup display on the TV screen.
- 30 AUDIO (page 26)***
Press to select the language of the sound track.
- 31 SUBTITLE (page 26)***
Press to display subtitles or turn them on/off.

* Used for operating a DVP-NW50 only

** Use the tactile dot as a reference when operating the system.

Continue to the next page ➞

Parts and Controls (continued)

Preparing the remote

Insert two R06 (size-AA) batteries into the battery compartment with the + and - correctly oriented to the markings. When using the remote, point it at the IR sensor **R** on the Unit.

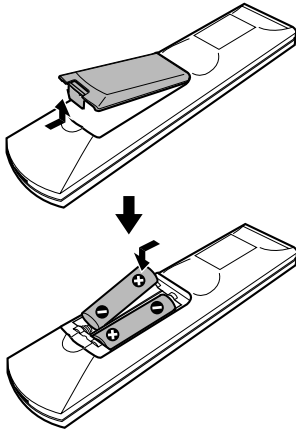

Notes

- Under normal conditions, the batteries should last for about six months. When the remote no longer operates the Unit, replace both batteries with new ones.
- Do not leave the remote in an extremely hot or a humid place.
- Do not drop any foreign object into the remote casing, particularly when replacing the batteries.
- Do not use a new battery with an old one.
- Do not expose the IR sensor to direct sunlight or lighting equipment. Doing so may cause a malfunction.
- If you do not intend to use the remote for an extended period of time, remove the batteries to avoid possible damage from battery leakage and corrosion.

Setting a remote code on the remote

You can switch the remote code (CIS2 or CIS3) on the remote. If the remote code of the Unit and the remote are different, you cannot use the remote to operate the Unit. Make sure that the remote code of the remote and the Unit is the same. For details on setting a remote code on the Unit, see page 13.

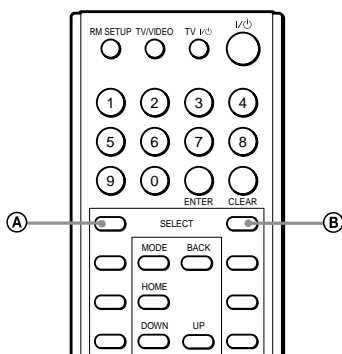

Press the **(A)** or **(B)** SELECT while "RM SETUP" is being pressed on the remote.

The default setting is CIS2.

When you press the **(A)** SELECT, remote code is set to CIS2.

When you press the **(B)** SELECT, remote code is set to CIS3.

Note

You cannot operate the Unit using the remote when the remote code of the Unit and the remote are different.

Menu operation

The Home Menu is displayed on the Unit **(A)**.

Using the Home Menu, you can select the sound and make various adjustments to items.

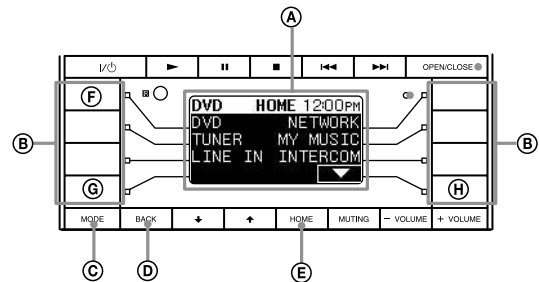

Using any SELECT **(B)**, you can select an item on the front panel display.

When the item is displayed on the left side, press a SELECT on the left side.

When the item is displayed on the right side, press a SELECT on the right side.

For example, when you want to select "DVD," press the **(F)** SELECT.

When you want to see items below those currently displayed, press the **(H)** SELECT.

(When there are additional items, "▼" is displayed).

When you want to see items above those currently displayed, press the **(G)** SELECT.

(When there are additional items, "▲" is displayed).

For details on the Menu tree, see the next page.

(C) Press to jump to the Mode Menu of each function.

(D) Press to return to the previous menu.

(E) Press to return to the top menu.

Menu tree

You can set the following items from Home Menu.

When you press MODE on each of the displays, the Mode Menus shown on the right side appear on the front panel display.

HOME

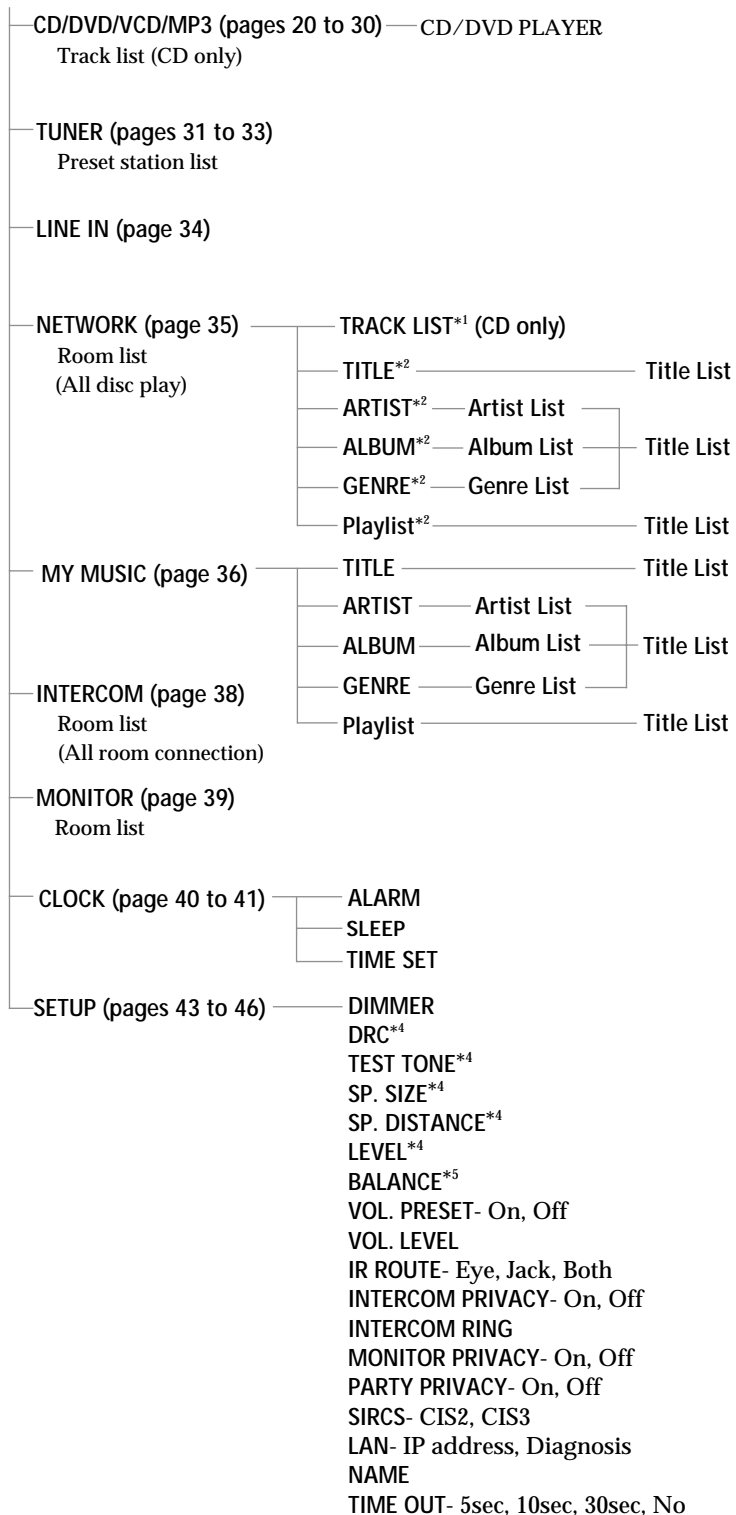

MODE MENU

CD/DVD
 Play mode*³ - Continue, Shuffle, Repeat
 Party mode- On, Off
 Party Join/Quit
 Surround mode*⁴

TUNER
 Mono/Stereo
 Band (FM/AM)
 Party mode- On, Off
 Party Join/Quit
 Surround mode*⁴

LINE IN
 Party mode- On, Off
 Party Join/Quit
 Surround mode

NETWORK
 Play mode- Continue, Shuffle, Repeat
 Party mode- On, Off
 Party Join/Quit
 Surround mode*⁴

MY MUSIC
 Play mode*³ - Continue, Shuffle, Repeat
 Party mode- On, Off
 Party Join/Quit
 Privacy mode- On, Off
 Surround mode*⁴

*¹ When you select an Unit in the Room list.

*² When you select a computer in the Room list.

*³ Available play mode is different for disc.
 DVD/VCD/MP3 : Continue, Repeat
 CD : Continue, Shuffle, Repeat

*⁴ DVP-NW50 only

*⁵ CDP-NW10 only

Chapter 3

Playing Discs

(CDP-NW10 only)

This chapter describes how to play a CD disc or how to play audio in various modes using the CDP-NW10.

Playing a CD Disc

- 1 Press I/⏻ (POWER).
The Unit turns on.
- 2 Press OPEN/CLOSE to open the door, then place a disc on the spindle firmly.

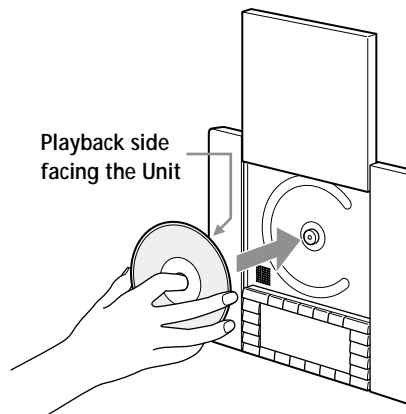

- 3 Press OPEN/CLOSE.
The door closes.
- 4 Press the "CD" SELECT on the Home Menu.
The track list appears on the front panel display. When the Unit has been connected to the Internet via a computer, the track titles are downloaded from the Gracenote CDDB® server, and the track titles appear on the front panel display. You can select and play back desired tracks from these lists. When the Unit is not connected to a computer or your computer is not connected to the Internet, only "TRACK1," "TRACK2," etc., appear on the front panel display.
- 5 Press ►.
When CD information is downloaded from Gracenote CDDB®, you can also press the "TRACK" SELECT.

To stop playing a disc

Press ■.

Additional operations

To	Press
Mute the sound	MUTING. To cancel muting, press it again or press VOLUME + to adjust the sound volume.
Select a track number	Numeric buttons (0-9). When the track number is between 1 and 9: press the corresponding numeric button, then press ►. When the track number is 10 or higher: press the corresponding numeric buttons in sequence. e.g.: Playback of the 14th track Press 1 → 4 in order.

Note

If there is no disc in the Unit or a disc that cannot be read by the Unit, "NO DISC" appears on the front panel display.

Various play mode functions (Shuffle play, Repeat play)

Shuffle play

You can play back tracks in random order.

- 1 Press MODE on the CD display.
The Mode Menu appears.

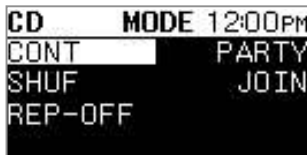

- 2 Press the "SHUF" SELECT.
"SHUF" is highlighted.
- 3 Press **▶** to start Shuffle play.
Shuffle Play starts.

Repeat play

- 1 Press MODE on the CD display.
The following display appears.



- 2 Press the **Ⓐ** SELECT repeatedly.
Repeat play starts from the selected track.
Each time you press the button, the play mode changes as shown below.

REP-OFF → REP1 → REP

About the playback range

Press "REP-OFF" (repeat off), "REP1" (repeat one), or "REP" (repeat all) SELECT repeatedly on Mode Menu.

The playback range may be different depending on the play mode.

SHUF (shuffle)

If you select	Plays
"REP-OFF"	All tracks on a disc randomly once.
"REP1"	A single track repeatedly.
"REP"	All tracks on a disc play repeatedly.

CONT (continue)

If you select	Plays
"REP-OFF"	All tracks on a disc play once.
"REP1"	A single track repeatedly.
"REP"	All tracks on a disc play repeatedly.

Searching for a particular point on a disc (Search/Scan)

You can quickly locate a particular point on a disc.

To locate a point quickly using the previous/next buttons (Search)

You can search for the next or previous track using **⏪** / **⏩** on the Unit.

Press **⏪** or **⏩** lightly once to go to the next or previous track during playback.

To locate a point quickly by playing a disc in fast forward or fast reverse (Scan)

- 1 Press **⏩** or **⏪** during playback on the remote.
- 2 When you find the point you want to play back while scanning, press **▶** to return to normal speed. Fast forwarding or reversing stops and returns to the normal playback when the track goes to the next track or previous track.

Chapter 4

Playing Discs

(DVP-NW50 only)

This chapter describes how to play CD or DVD discs, and the settings and functions related to a DVD player.

Playing a CD Disc

- 1 Press I/⏻ (POWER).
The Unit turns on.
- 2 Press OPEN/CLOSE to open the door, then place a disc on the spindle firmly.

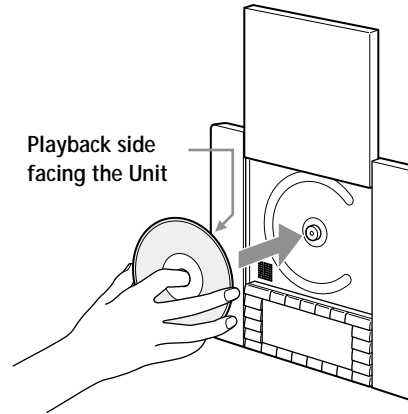

- 3 Press OPEN/CLOSE.
The door closes.
- 4 Press the "DVD" SELECT on the Home Menu.
The track list appears on the front panel display. When the Unit has been connected to the Internet via a computer, the track titles are downloaded from the Gracenote CDDDB® server, and the track titles appear on the front panel display. You can select and play back desired tracks from these lists. When the Unit is not connected to a computer or your computer is not connected to the Internet, only "TRACK1," "TRACK2," etc., appear on the front panel display.
- 5 Press ►.
When CD information is downloaded from Gracenote CDDDB®, you can also press the "TRACK" SELECT.

To stop playing a disc

Press ■ twice.

Additional operations

To	Press
Mute the sound	MUTING. To cancel muting, press it again or press +VOLUME to adjust the sound volume.
Select a track number	Numeric buttons (0-9). When the track number is between 1 and 9: press the corresponding numeric button, then press ►. When the track number is 10 or higher: press the corresponding numeric buttons in sequence. e.g.: Playback of the 14th track Press 1 → 4 in order.

Note

If there is no disc in the Unit or a disc that cannot be read by the Unit, "NO DISC" appears on the front panel display.

Various play mode functions (Shuffle play, Repeat play)

Shuffle play

You can play back tracks in random order.

- 1 Press MODE on the CD display.
The Mode Menu appears.

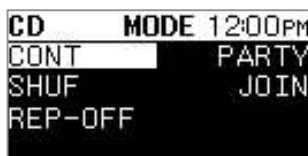

- 2 Press the "SHUF" SELECT.
"SHUF" is highlighted.
- 3 Press  to start Shuffle play.
Shuffle Play starts.

Repeat play

- 1 Press MODE on the CD display.
The following display appears.



- 2 Press the  SELECT repeatedly.
Repeat play starts from the selected track.
Each time you press the button, the play mode changes as shown below.

REP-OFF → REP1 → REP

About the playback range

Press "REP-OFF" (repeat off), "REP1" (repeat one), or "REP" (repeat all) SELECT repeatedly on Mode Menu.

The playback range may be different depending on the play mode.

SHUF (shuffle)

If you select	Plays
"REP-OFF"	All tracks on a disc randomly once.
"REP1"	A single track repeatedly.
"REP"	All tracks on a disc play repeatedly.

CONT (continue)

If you select	Plays
"REP-OFF"	All tracks on a disc play once.
"REP1"	A single track repeatedly.
"REP"	All tracks on a disc play repeatedly.



Playing a DVD/VCD/MP3 Disc

Depending on the disc used, some operations may be different or restricted.

For details, refer to the instructions supplied with your disc.

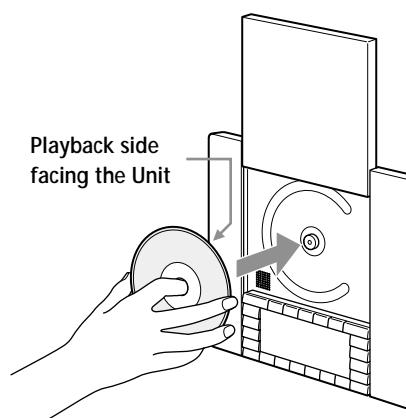
- 1 Turn on your TV.
- 2 Press I/⏻ (POWER).
The Unit turns on.
- 3 Switch the input selector on your TV so that the signal from the Unit appears on the TV screen.
- 4 Press OPEN/CLOSE on the Unit, and place a disc on the disc spindle firmly.





- 5 Press OPEN/CLOSE.
The door closes.
- 6 Press the "DVD" on the Home Menu.
- 7 Press .
The Unit starts playback.
Adjust the volume on the Unit.
Depending on the disc, a menu may appear on the TV screen, and playback may start automatically even if you do not press .
For DVD VIDEOS and VIDEO CDs, see page 24.

To stop playing the disc

Press  twice.

To resume playback from the point where you stopped the disc

- 1 Press  during playback.
- 2 Press .
The Unit starts playback from the point where you stopped the disc in step 1.

Continue to the next page 

Repeat play

- 1 Press MODE on the DVD display. The following display appears.



- 2 Press the (A) SELECT repeatedly.

When playing a DVD

If you select	Plays
"REP-OFF"	All tracks on a disc once.
"REP-CHAP"	A single chapter repeatedly.
"REP-TITL"	A single title repeatedly.
"REP"	All chapters on a disc repeatedly.

When playing a MP3 file

If you select	Plays
"REP-OFF"	All MP3 files in the current folder once.
"SINGLE"	The current MP3 file once.
"REP1"	The current MP3 file repeatedly.
"REP"	All MP3 files in the current folder repeatedly.

When playing a VIDEO CD (Ver. 1.1) without PBC functions

If you select	Plays
"REP-OFF"	All tracks on a disc once.
"REP1"	A single track repeatedly.
"REP"	All tracks on a disc repeatedly.

- 3 Press ► to start Repeat Play. Repeat Play starts.

Note

When you play a VIDEO CD (Ver. 2.0) with PBC functions, repeat play does not work.

Using the DVD's menu **DVD-V**

A DVD is divided into long sections of a movie or a music feature called "titles."

When you play DVDs which contains several titles, you can select the title using the TOP MENU on the remote. When you play DVDs that allow you to select items such as language for the sound and subtitles, select these items using the MENU on the remote.

- 1 Press TOP MENU or MENU on the remote. The disc menu appears on the TV screen. The contents of the menu differ from disc to disc.
- 2 Press ⬅/➡ on the remote to select the item you want to play or change.
- 3 Press ENTER on the remote.

Playing VIDEO CDs with PBC functions (VIDEO CD Ver. 2.0 or higher) **VCD**

PBC (PlayBack Control) allows you to play VIDEO CDs interactively by following the menu on the TV screen.

- 1 Press ►. If you insert a VIDEO CD (Ver.2.0 or higher), the VIDEO CD starts playing with PBC functions. The menu used by your selection appears.
- 2 Press the numeric buttons on the remote to select the item number you want.
- 3 Press ENTER on the remote.
- 4 Follow the instructions on the menu for interactive operations. Refer to the instructions supplied with the disc, as the operating procedure may differ, depending on the VIDEO CD.

Note

Depending on the VIDEO CD, "Press ENTER on the remote" in step 3 may appear as "Press SELECT" in the instructions supplied with the disc. In this case, press ►.

Playing an MP3 audio track **DATA CD**

You can play MP3 audio tracks on CD-ROMs, CD-Rs, or CD-RWs. However, the discs must be recorded according to ISO9660 level 1, or Joliet format for the Unit to recognize the tracks.

- 1 Insert a data disc recorded in MP3 format into the Unit. A folder list is displayed on the TV screen.



- 2 Press \uparrow/\downarrow to select the folder you want to play, then press ENTER on the remote. File list is appears under the folder.



- 3 Press \uparrow/\downarrow to select the file you want to play, then press ENTER on the remote. The Unit starts playing the first MP3 audio track on the disc.

Notes

- The Unit can play MP3 (MPEG1 Audio Layer3) audio. The Unit cannot play audio tracks in MP3PRO format.
- If an MP3 file of VBR (variable bit rate) is played, indicated the elapsed time may be different from the actual time.
- If you add the extension ".MP3" to data that is not in MP3 format, the Unit cannot recognize the data properly and will generate a loud noise which could damage your speakers.
- You can enter up to 50 characters as a file name including an extension.
- A file or folder name that is not based on the ISO level 1 or Joliet format may not be displayed properly.
- The total number of file or folder names should be 128, or fewer.
- There should be no more than 128 levels in the folder tree.
- Do not use characters such as <, >, &, |, ", /, ?, *, ', \, :, etc.

Searching for a Scene

Searching for a particular point on a disc (Search/Scan) **DVD-V VCD CD**

You can quickly locate a particular point on a disc by monitoring the picture or playing it back slowly.

Note

Depending on the disc, you may not be able to do some of the operations described here.

To locate a point quickly using the previous/next buttons (Search)

You can search for the next or previous chapter, track, or scene using \lll / \ggg on the Unit.

Press \lll or \ggg lightly once to go to the next or previous chapter/track/scene during playback.

To locate a point quickly by playing a disc in fast forward or fast reverse (Scan)

- 1 Press \lll or \ggg during playback on the remote.
- 2 When you find the point you want to play back while scanning, press \triangleright to return to normal speed. Fast forwarding or reversing stops and returns to the normal playback when the track goes to the next track or previous track. Each time you press \lll or \ggg while scanning, the scanning speed changes. With each press, the indication changes as shown below. Actual speeds may differ between discs.

Playback direction



Opposite direction

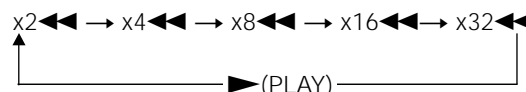

Searching for a title/chapter/track, etc. (Search mode) **DVD-V**

You can search a DVD by title or chapter, and you can search a VIDEO CD by track. As titles and tracks are assigned unique numbers on the disc, you can select the desired one by entering its number.

Continue to the next page \Rightarrow

Searching for a scene (continued)

- 1 Press **DISPLAY** on the remote.
The following display appears. The number in parentheses indicates the total number of titles, tracks, etc., of the disc.



Press **←/→/▲/▼** repeatedly to select a search method on the remote.

When playing a DVD VIDEO/DVD-RW

TITLE
CHAPTER

When playing a VIDEO CD

TRACK

- 3 Select the number of the title, chapter, track, time code, etc. you want by pressing the numeric buttons to select the digit.
The Unit starts playback from the selected number or time.

To turn off the display

Press **DISPLAY** on the remote repeatedly until the display is turned off.

Notes

- The title, chapter, or track number displayed is the same number as that of recorded on the disc.
- You cannot search for a scene on a DVD+RW using the time code.

Using Various Additional Functions

The following operations are set up using the remote while looking at a TV screen.

Selecting the audio **DVD-V**

Switches the language of the sound track.

Press **AUDIO** on the remote while playing a disc. Each time you press **AUDIO** on the remote, the language of the sound track changes.

Note

Depending on the DVD VIDEO, you cannot change the audio setting even if multilingual audio are recorded on the disc. In this case, use the DVD's menu (page 24).

Selecting the subtitles **DVD-V**

If subtitles are recorded on the disc, you can change the subtitles, or display or hide them whenever you want, while playing a DVD.

Press **SUBTITLE** on the remote while playing a disc. Each time you press **SUBTITLE** on the remote, the subtitle of the DVD changes.

If you want to hide the subtitle from the TV screen, press **SUBTITLE** on the remote until the display shows **SUBTITLE OFF** on the TV screen.

Note

Depending on the DVD VIDEO, you cannot change subtitles even if multilingual subtitles are recorded on the disc. In this case, use the DVD's menu (page 24).

Selecting the angle **DVD-V**

You can change the angles even if various angles (multi-angles) for a scene are recorded on the DVD VIDEO. When "Angle Mark" is set to "ON" in the setup display, angle mark is displayed on the TV screen (page 29).

Press **ANGLE** on the remote while playing a disc. Each time you press **ANGLE** on the remote, the angle of the DVD changes.

Parental control (limited playback) DVD-V

The following operations are set up using the remote while looking at a TV screen.

The "PARENTAL CONTROL" function allows you to set a playback limitation level.

Playback of some DVD VIDEOS can be limited according to a predetermined level, such as the age of the users.

- 1 Press DVD SETUP on the remote when the Unit is in stop mode.

The Setting Menu appears.



- 2 Press \leftarrow/\rightarrow to select  (Preference,) then press ENTER or \downarrow on the remote.

The options for "Preference" appear.



- 3 Press \uparrow/\downarrow to select "Parental," then press ENTER or \downarrow on the remote.

The items for "Parental level" are displayed.

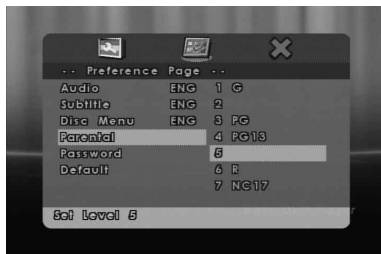

- 4 Press \uparrow/\downarrow to select level items, then press ENTER on the remote.

The lower the value, the stricter the limitation.

- 5 Enter or re-enter your 4-digit password using the numeric buttons, then press ENTER on the remote. When the level is not changed, the display does not appear.

To turn off the parental control function

- 1 Press \uparrow/\downarrow to select "OFF" in step 4 above, then press ENTER on the remote.
- 2 Enter your 4-digit password using the numeric buttons, then press ENTER on the remote.

To play a disc for which parental control is set

- 1 Insert the disc for which Parental Control is set.
- 2 Enter your 4-digit password using the numeric buttons, then press ENTER on the remote. The Unit is ready for playback.

To change the password

- 1 Press \uparrow/\downarrow to select "Password" on the Preference Display, then press ENTER on the remote.
- 2 "Change" is highlighted, then press ENTER on the remote. The display used for entering the password appears.
- 3 Enter your 4-digit password using numeric buttons on the remote.



- 4 Enter a new 4-digit password using numeric buttons on the remote.



Continue to the next page \rightarrow

Using Various Additional Functions (continued)

- To confirm your password, re-enter the new 4-digit password using the numeric buttons on the remote. If you make a mistake entering your password, re-enter your correct password.



- Press ENTER on the remote.

Tip

If you forget your password, or the first time you change the password, enter the 4-digit number "9703" as old password using the numeric buttons.

Notes

- When you play discs which have the parental control function, playback of the disc is limited on the Unit.
- Depending on the disc, you may be asked to enter your password when playback starts. In this case, enter the password.

Using the Setup Display (DVD Settings)

By using the Setup Display, you can make various adjustments to items such as picture and sound. You can also set a language for the subtitles and the Setup Display. For details on each Setup Display item, see pages from 28 to 30.

Setting the display (General Setup)

DVD-V CD DATA CD

Choose settings according to the TV to be connected.

- Press DVD SETUP on the remote when the Unit is in stop mode.
The Setting Menu appears.
- Press \leftarrow/\rightarrow to select (General Setup,) then press ENTER or \downarrow on the remote.
The options for "General Setup" appear.



- Press \uparrow/\downarrow to select an option, then press ENTER on the remote.
The options for the selected item appear.



- Press \uparrow/\downarrow to select an item, then press ENTER on the remote.

TV Type

Select the color system of the TV to be connected.

The setup may be different in depending on regions or countries.

The default setting is underlined.

<u>NTSC</u>	Outputs the NTSC color system.
PAL	Outputs the PAL color system.
AUTO	Outputs the color system that is recorded on the disc.

TV Display

Selects the aspect ratio of the connected TV screen (4:3 standard or wide).

Depending on the disc, "Normal/LB" may be selected automatically instead of "Normal/PS" or vice versa. The default setting is underlined.

Normal/PS
(4:3 PAN SCAN)

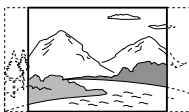

Select this when you connect a 4:3 screen TV. Automatically displays a wide picture on the entire screen and cuts off the portions that do not fit.

Normal/LB
(4:3 LETTER BOX)



Select this when you connect a 4:3 screen TV. Displays a wide picture with bands on the upper and lower portions of the screen.

16:9 Wide

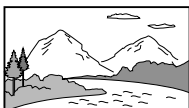

Select this when you connect a wide-screen TV or a TV with a wide mode function.

Angle Mark (page 26)

When you select "ON," and various angles (multi-angles) for a scene are recorded on the DVD VIDEO, an angle mark is displayed on the TV screen.

The default setting is "ON."

OSD Lang (On-Screen Display Language)

Switches the display language on the screen.

Captions

The hidden subtitle is displayed or turn off.

The default setting is "ON."

Screen Saver

The screen saver image appears when you leave the Unit in pause or stop mode for five minutes. The screen saver will help prevent your display device from becoming damaged (ghosting). Press any button to turn off the screen saver.

The default setting is underlined.

<u>ON</u>	Turns on the screen saver.
OFF	Turns off the screen saver.

Setting the language and playback restriction (Preference) **DVD-V**

Choose settings according to the TV to be connected.

- 1 Press DVD SETUP on the remote when the Unit is in stop mode.
The Setting Menu appears.
- 2 Press \leftarrow/\rightarrow to select  (Preference,) then press ENTER or \downarrow on the remote.
The options for "Preference" appear.



- 3 Press \uparrow/\downarrow to select an option, then press ENTER on the remote.
The options for the selected item appear.



- 4 Press \uparrow/\downarrow to select an item, then press ENTER on the remote.

Audio (page 26)

Switches the language of the sound track.

Subtitle (page 26)

Switches the language of the subtitle.

Disc Menu

Select the desired language for the disc menu.

Parental (page 27)

Playback of some DVD VIDEOS can be limited according to a predetermined level, such as the age of the users.

Password (page 27)

Set the 4-digit password in parental control.

Continue to the next page \rightarrow

Using the Setup Display (DVD Settings) (continued)

Default (this page)

All the settings explained on pages from 28 to 29 return to the default settings.

Tip

If you select "OTHERS" in "Audio," "Subtitle," or "Disc Menu," select and enter a language code from the language code list (page 55) using the numeric buttons.

- 4 Select "Reset," then press ENTER on the remote. All the settings explained on pages from 28 to 29 return to the default settings. Do not press **I/⏻** (POWER) while resetting the Unit. It may take a few seconds to complete.

To reset all of the settings

- 1 Press DVD SETUP on the remote when the Unit is in stop mode. The Setting Menu appears.



- 2 Press **⇐/⇒** to select **Preference** (Preference,) then press ENTER on the remote. The options for "Preference" appear.



- 3 Press **⇐/⇒** to select "Default," then press ENTER on the remote.



Chapter 5

Enjoying Radio and Other Component

This chapter describes how to receive FM/AM stations, and listen to sound from a component connected to LINE IN using the Unit.

Listening to the Radio

You can tune in stations on the Unit by preset tuning or manual, automatic, or direct tuning.

Listening to a preset station

Preset FM/AM radio stations in the Unit's memory first. For details on how to preset radio stations in the Unit, see page 33.

- 1 Press "TUNER" SELECT on the Home Menu.
The display changes to the Tuner display, then the Preset station list appears.

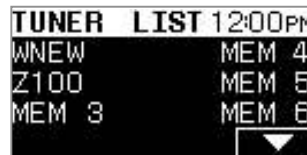

- 2 Press any SELECT.
The display changes to the current station display.



Listening to a non-preset station

- 1 Press the "TUNER" SELECT on the Home Menu.
The display changes to the Tuner display, then the Preset station list appears.

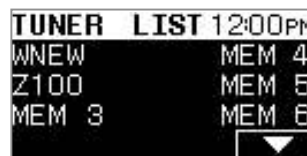

Continue to the next page ➞

Listening to the Radio (continued)

- 2 Press MODE to switch the band to AM (or FM).
The Tuner mode Menu appears.



- 3 Press the "AM" (or "FM") SELECT, then press BACK.
The display returns to the current frequency.

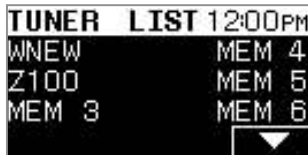

- 4 Press any SELECT.
The display changes to the current frequency.



- 5 Press DOWN/UP on the remote to adjust the frequency.

DOWN/UP	Changes the current frequency to a frequency 1 step lower or higher. (Manual tuning)
---------	--

DOWN/UP (press and hold)	Scans a particular station toward a lower or higher frequency. Scanning stops automatically when the station is tuned in. (Automatic tuning)
--------------------------	--

When you know the frequency of the station

Press the numeric buttons on the remote to enter the frequency (Direct tuning).

Example: FM 105.70 MHz

1 → 0 → 5 → 7 → 0



Tip

You can tune in the station in 100 kHz steps for the FM band and 10 kHz steps for the AM band.

Notes

- When you press the "8" or "9" numeric button, the number appears in the second entry position.
- When you enter invalid numbers, the direct tuning is cancelled and the screen returns to the current station display.
- Tuning interval for direct tuning is:
FM: 78.50 MHz to 108.00 MHz
AM: 530 MHz to 1710 MHz

Presetting Radio Stations

After you have tuned in stations using direct tuning or Automatic tuning, you can preset them to the Unit. Up to 20 FM or AM stations can be preset.

- 1 Press "TUNER" SELECT on the Home Menu. The display changes to the Tuner display, then the Preset station list appears.



- 2 Press any SELECT that corresponds to the station you want to tune in. The display changes to the current station display.
- 3 Tune in to the station that you want to preset (page 31).



- 4 Press the "MEM" (memory) SELECT to enter your selection.

Naming the Preset Stations

You can edit the name of the preset stations in the Preset station list.

- 1 Press the "TUNER" SELECT on the Home Menu. The display changes to the Tuner display, then the Preset station list appears.

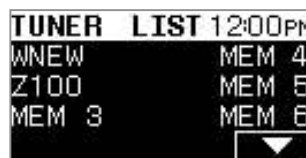

- 2 Press and hold any SELECT of the station of which you want to edit the name. The display changes to the Text edit display.
- 3 Enter the name in the text box using the function SELECT. See the table below for details on the function of each of the buttons.



- Ⓐ Moves the cursor to the left in the text being edited (Text Edit).
 - Ⓑ Changes characters in reverse alphabetical order.
 - Ⓒ Clears the character on which the cursor is placed in the text being edited (Text Edit).
 - Ⓓ Cancels editing and returns to the Preset station list.
 - Ⓔ Moves the cursor to the right in the text being edited (Text Edit).
 - Ⓕ Changes characters in alphabetical order.
 - Ⓖ Enters the selected character into the text box.
 - Ⓗ Stores the name and returns to the Preset station list.
- 4 Press the "RETURN" SELECT. The name of the preset station is stored, then the display returns to the Preset station list.

Listening to Sound from a Component Connected to LINE IN

You can listen to music from an external source if the Unit is connected to another playback component, such as a CD changer, etc.

- 1 Press the "LINE IN" SELECT on the Home Menu.
The LINE IN display appears.

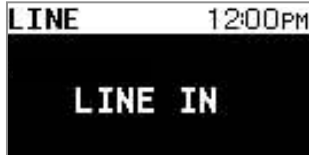

- 2 Play back the component connected to the Unit.
The sound from the component is output via the Unit.
You can adjust the volume of the Unit with + VOLUME and - VOLUME on the Unit.

To edit the name of the LINE IN source

You can change "LINE IN" to something more recognizable and have it displayed on the front panel display.

- 1 Press and hold the "LINE IN" SELECT.
The Text edit Menu appears.

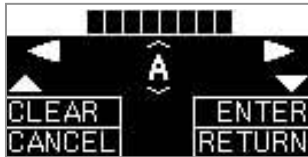

- 2 Enter the name in the editing text box using the SELECT.
See "Naming the Unit" on page 12 for details on how to enter characters.

Chapter 6

Using the System Network

This chapter describes how to use network functions among Units and computers, etc. You can enjoy music, and use the intercom and the monitor function connecting each of the Units via an Ethernet cable.

Playing Music on Other Units

You can play back and share the music content in all Units and computers via an Ethernet cable. There are two types of source used to play back music content. One is “NETWORK,” and the other is “MY MUSIC.”

If a computer is connected to the Internet, you can get the CD information from the Gracenote CDDB® server.

Playing back music from “NETWORK”

When you select “NETWORK,” audio CDs on other Units and MP3-format music files on your computer are played back.

- 1 Press the “NETWORK” SELECT on the Home Menu. The Room list appears.

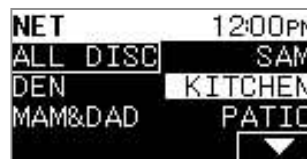

- 2 Press any SELECT to select a Unit or a computer. If the source you select is allocated to a Unit, the Track list appears. If the source you select is allocated to a computer, the Browse Menu appears. Go to step 2 in “Playing back music from “MY MUSIC” on page 36.
- 3 Press any SELECT to select a track to be played back. The playback display appears, and playback starts.

Notes

- Each Unit appears with an original name if you have changed the name of the Unit. See “Naming the Unit” on page 12 for details on how to change the names of Units.
- When using network music, some of the functions or the access to the other Units are restricted.
- Some music files stored on the hard disk of your computer may not be able to be played back on the Unit. For example, depending on file format, some music files may not be played back on the Unit.

Continue to the next page ➞

Playing Music on Other Units (continued)

Playing back music from "MY MUSIC"

When you select "MY MUSIC," audio CDs in other Units and MP3-format music files from your computers are played back.

When the Unit has been connected to the Internet via a computer, CD information, such as artist name, album and track titles, or genre, are downloaded from the Gracenote CDDB® server, and sorted into "TITLE," "ARTIST," "ALBUM," and "GENRE." These information appear on the front panel display.

You can select and play back desired tracks from these lists. When the Unit is not connected to a computer or your computer is not connected to the Internet, only "TRACK1," "TRACK2," etc., appear on the front panel display.

- 1 Press the "MY MUSIC" SELECT on the Home Menu. The Browse list appears.



- 2 Press any SELECT to select a list from "TITLE," "ARTIST," "ALBUM," "GENRE," or "PLAYLIST."* The selected list appears. If you select "TITLE," a Track list appears. Skip to step 4.
 - * If you press "TITLE," "ARTIST," "ALBUM" or "GENRE" SELECT, each list is sorted and appears based on the CDDB information. If you press "PLAYLIST" SELECT, the playlist registered using the Utility In-Wall Unit software on the computer appears.
- 3 Press any SELECT to select an artist, genre, or a playlist title according to the list you select in step 2.
- 4 Press any SELECT to select a track to be played back. The playback display appears, and playback starts.

Various play mode functions (Shuffle play, Repeat play)

"NETWORK" and "MY MUSIC" have two play modes.

Shuffle play

You can play back tracks in random order. For details on "Shuffle play" see page 21.

Repeat play

For details on "Repeat play" see page 21.

Tip

If you select "ALL DISC" during NETWORK playback, the Unit plays tracks on the disc randomly. When the disc finishes, it selects the next disc to be played back at random.

Enjoying Music in All Rooms Simultaneously (Party mode)

Using the Party mode function, you can share the music content among multiple Units simultaneously. You can also exclude a selected room from the Party mode (Party Privacy).

Source and play modes available in the Party mode are the following:

- NETWORK/MY MUSIC
 - CDs inserted into Units in which the Party Privacy is set to off.
 - MP3-format music files stored on the hard disc drive of a computer.
- CD/DVD
 - CDs (when using a CDP-NW10)
 - CDs, Data CDs (MP3) (when using a DVP-NW50)
- A device connected via LINE IN
 - Sound output from a device connected via LINE IN.
- Tuner
 - A station currently tuning in.

- 1 Press **MODE** after selecting a source on the Home Menu.

The Mode Menu appears.

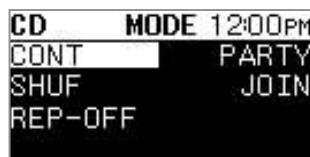

e.g.
When you press **MODE** while playing a CD.

- 2 Press the **"PARTY"** SELECT.

"Party" appears on the right side of the top line on the front panel display.

The Unit enters the Party mode, and music is output to the rooms.

Tip

In the Party mode, some playback operations such as stop, play, etc., are operable on all of the Units.

To cancel the Party mode

You can cancel the Party mode from any of the Units even if the Unit is not in the Party mode.

Press the highlighted **"PARTY"** SELECT on the Mode Menu using the same procedure you used when you activate the Party mode.

Excluding the Unit from a Party mode (Party Privacy)

If you set the Party Privacy in a selected Unit, you can operate that Unit individually even if other Unit is in the Party mode.

The setting is retained even if you turn off the Unit.

- 1 Press the **"▼"** SELECT on the Home Menu, then press the **"SETUP"** SELECT.
The Setup Menu appears.

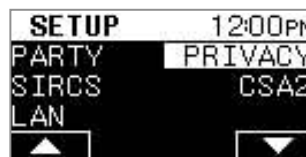

- 2 Press the **"PRIVACY"** SELECT.
"PRIVACY" is highlighted.
The Unit enters the Party Privacy mode.

Tips

- When you want to join the Party mode, press **MODE**, then the **"JOIN"** SELECT on the Mode Menu. If the Unit has already joined in the Party mode, **"QUIT"** is displayed on the Mode Menu.
- When you want to quit the Party mode, press **MODE**, then the **"QUIT"** SELECT on the Mode Menu. If the Unit has not joined in the Party mode, **"JOIN"** is displayed on the Mode Menu.

Talking with Persons in Other Rooms (INTERCOM)

You can talk with person in any room using the Intercom function. While INTERCOM is set to ON, the internal speaker is activated and speakers connected to the Unit are muted. The streaming on the network stops until the intercom connection is terminated on both of the sending and receiving rooms.

- 1 Press the "INTERCOM" SELECT on the Home Menu. The Room list appears.



- 2 Press any SELECT to select the room you want to contact. If the room you want to contact is not displayed on the front panel display, press the "▼" SELECT to display the next page. The INTERCOM display appears, and connection is established after the receiving room answers.



- 3 To cancel the intercom connection, press the "OFF" SELECT on the Intercom display.

To answer INTERCOM

Press the "ANSWER" SELECT in the receiving room.



Notes

- If there is no answer from the room you are trying to contact, the connection is terminated automatically in 10 seconds.
- Connection between rooms terminates automatically 30 seconds after the receiving room answers.
- Connection can be terminated by pressing the "OFF" SELECT from either the sending or receiving room.
- A Unit can call up all the rooms using the INTERCOM function, but only one room can answer the call. Connections to rooms other than the answering room are disconnected.

To adjust the speaker level during INTERCOM

The volume of the INTERCOM function is independent from that in audio control.

Adjust the volume with + VOLUME and - VOLUME on the Unit while the INTERCOM connection is established.

Excluding a Unit from INTERCOM (Intercom Privacy)

Any room in which the Intercom Privacy is set to ON, does not receive the Intercom signal.

- 1 Press the "▼" SELECT on the Home Menu, then press the "SETUP" SELECT. The Setup Menu appears.
- 2 Press the "▼" SELECT repeatedly until "INTERCOM PRIVACY" appears on the front panel display.
- 3 Press the (A) or (B) SELECT to activate Intercom Privacy mode. "PRIVACY" is highlighted and the Intercom Privacy is set to ON.



Press the (A) or (B) SELECT to exit the Intercom Privacy.

Changing the call sound of the INTERCOM

You can change the call sound heard when the room receives an intercom signal.

- 1 Press the "▼" SELECT on the Home Menu, then press "SETUP" SELECT. The Setup Menu appears.
- 2 Press the "▼" SELECT repeatedly until "INTERCOM RING" appears on the front panel display.
- 3 Press the (A) or (B) SELECT to select the sound.



Monitoring Other Rooms (MONITOR)

You can monitor other rooms via the Unit. While MONITOR is set to ON, the internal speaker is activated and speakers connected to the Unit are muted. The streaming on the network stops until the monitor connection is terminated on the both of monitoring and monitored Units.

- 1 Press the "▼" SELECT on the Home Menu, then press "MONITOR" SELECT.
The Room list appears.



- 2 Press any SELECT to select the room you want to monitor.

If the room you want to monitor is not displayed on the front panel display, press the "▼" SELECT to display the next page.

The Monitoring display appears, and a connection with the room is established.



- 3 To cancel monitoring, press the "OFF" SELECT.

Note

Monitoring continues until MONITOR is canceled.

To adjust the speaker level during MONITOR

The volume of the Monitor function is independent from that in audio control.

Adjust the volume with + VOLUME and - VOLUME on the Unit while MONITOR connection is established.

Excluding a Unit from MONITOR (Monitor Privacy)

You cannot monitor a room, for which the Monitor Privacy is set to ON.

- 1 Press the "▼" SELECT on the Home Menu, then press the "SETUP" SELECT.
The Setup Menu appears.
- 2 Press the "▼" SELECT repeatedly until "MONITOR PRIVACY" appears on the front panel display.
- 3 Press the (A) or (B) SELECT to activate Monitor Privacy mode.
"PRIVACY" is highlighted and the Monitor Privacy mode is set to ON.

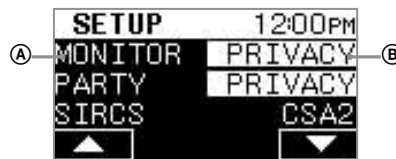

Press the (A) or (B) SELECT again to exit the Monitor Privacy.

Chapter 7

Setting the Timer

This chapter provides you with information on setup of the timer.

Setting the Alarm

You can set the Unit to turn on automatically at a specified time.

- 1 Press the "▼" SELECT on the Home Menu, then press the "CLOCK" SELECT. The Clock Menu appears.



- 2 Press the "ALARM" SELECT. The Alarm set Menu appears.



- 3 Check to see if the desired source for the alarm is selected and displayed in the upper right on the front panel display. If not, press the "FUNC" SELECT repeatedly to select a source. The playback source changes as shown below.

CD/DVD → TUNER → LINE

- 4 Set the hour and minute with the "HOUR" and "MIN" SELECT.
- 5 Press the "ON" SELECT. The default setting is "OFF." The alarm is set up, and "ON" is displayed.
- 6 Press I/⏻ (POWER) to turn off.

To set the alarm "OFF"

Press the "OFF" SELECT in step 5.

Setting the Sleep Timer

You can set the Unit to turn off automatically at a specified time.

- 1 Press the "▼" SELECT on the Home Menu, then press the "CLOCK" SELECT.
The Clock Menu appears.

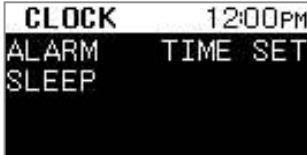

- 2 Press the "SLEEP" SELECT.
The Sleep timer Menu appears.



- 3 Press the "SELECT" SELECT.
Each time you press the button, the time changes as shown below.

OFF → 1:30 → 1:00 → 0:30

Chapter 8

Other Functions

This chapter describes the setup of the front panel display, sound field, and speakers.

Using the Setup Display

You can set up the sound on the Unit.

Selecting the surround mode (DVP-NW50 only)

- 1 Press **MODE** on the DVD display. The following display appears.

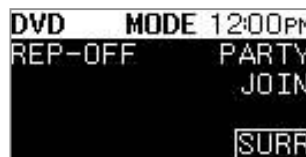

- 2 Press the "SURR" **SELECT**. The following display appears.



- 3 Press any **SELECT** to select the desired surround mode from the following selections. See the explanations given for each item in the following section.

2CH STEREO (2CH)

Outputs the sound from the front left and right speakers only. Standard two channel (stereo) sources completely bypass any processing. Multi channel surround formats are downmixed to two channels.

A.F.D. (AUTO FORMAT DIRECT)

Surround mode is decoded as it is recorded on the disc, without adding any effects (e.g. reverberation).

DOLBY PL (Dolby Pro Logic)

Performs Dolby Pro Logic decoding. A source recorded in 2 channels is decoded into 4 channels.

DOLBY PL II (Dolby Pro Logic II)

Performs Dolby Pro Logic II Movie decoding. This setting is ideal for movies encoded in Dolby Surround. In addition, this mode can reproduce sound in 5.1 channel when watching videos of old movies or with dubbed language.

To return to the previous display

Press **BACK**.

Note

When an input signal (e.g., multi channel, etc.) other than from a 2 channels source is input, "DOLBY PL" and "DOLBY PL II" are decoded into "A.F.D."

Adjusting the contrast of the front panel display (DIMMER)

- 1 Press the "▼" SELECT on the Home Menu, then press the "SETUP" SELECT.
The Setup Menu appears.



- 2 Press the "DIMMER" SELECT to activate DIMMER. "ON" and "OFF" are toggled as you press the "DIMMER" SELECT.
The default setting is "OFF."

Presetting the volume when the power is turned on (VOL PRESET)

- 1 Press the "▼" SELECT on the Home Menu, then press the "SETUP" SELECT.
The Setup Menu appears.
- 2 Press the "▼" SELECT repeatedly until "VOL. PRESET" appears on the front panel display.
- 3 Press the "VOL. PRESET" SELECT to activate VOL. PRESET. "ON" and "OFF" are toggled as you press the "VOL. PRESET" SELECT.
The default setting is "OFF."



- 4 Adjust the volume by pressing the (A) or (B) SELECT. The volume increases or decreases by 1(vol) step as you press the (A) or (B) SELECT.
The default setting is set to "MIN."

Adjusting the front speaker balance (BALANCE) (CDP-NW10 only)

- 1 Press the "▼" SELECT on the Home Menu, then press the "SETUP" SELECT.
The Setup Menu appears.

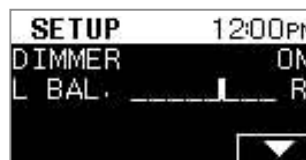

- 2 Press the (A) or (B) SELECT to adjust the front speaker balance between the left and right speakers.
The balance can be adjusted ± 8 steps in left and right position.



Settings for Speakers (DVP-NW50 only)

To obtain the best possible surround sound, set the size of the speakers you have connected and their distance from your listening position. Then use the test tone to adjust the volume of the speakers to the same level.

Selecting a speaker size

Set the speaker size to match the size of the speakers you are using. This setting is concerned with bass management and downmix function. The list below describes the available settings for each of the speakers.

Sub Woofer (S.WOOFER)

Speaker Size	Function
YES	Select this if you have connected a sub woofer speaker.
NONE	Select this if you have not connected a sub woofer speaker.

Front Speakers (FRONT)

Speaker Size	Function
LARGE	Normally select this position. SMALL cannot be selected if sub woofer is set to "NONE."
SMALL	Select this when the speaker cannot reproduce adequate bass frequencies.

Center Speakers (CENTER)

Speaker Size	Function
LARGE	Normally select this position. LARGE cannot be selected if front speaker is set to "SMALL."
SMALL	Select this when the speaker cannot reproduce adequate bass frequencies.
NONE	Select this if you have not connected a center speaker.

Rear Speakers (SURROUND)

Speaker Size	Function
LARGE	Normally select this position. LARGE cannot be selected if front speaker is set to "SMALL."
SMALL	Select this when the speaker cannot reproduce adequate bass frequencies.
NONE	Select this if you have not connected a surround speaker.

- 1 Press the "▼" SELECT on the Home Menu, then press the "SETUP" SELECT.
The Setup Menu appears.
- 2 Press the "▼" SELECT repeatedly until "SP. SIZE" appears.
- 3 Press the "SP. SIZE" SELECT.
The Speaker size setup Menu appears.
- 4 Select the corresponding SELECT to select the speaker to be setup.
The size of speaker is toggled as you press any SELECT as shown above.
- 5 Repeat step 4 until you have selected all of the speakers.



SIZE	12:00PM
S. WOOFER	YES
FRONT	LARGE
CENTER	SMALL
SURROUND	NONE

Notes

- If you connect large speakers that will effectively reproduce bass frequencies, select "LARGE." Normally, select "LARGE."
- If the sound is distorted, or you feel a lack of surround effects when using multi channel surround sound, select "SMALL" to activate the bass redirection circuitry and output the front channel bass frequencies from the sub woofer.

About speaker sizes

Internally, the LARGE and SMALL settings for each speaker determine whether or not the internal sound processor will cut the bass signal from that channel. When the bass is cut from a channel the bass redirection circuitry sends the corresponding bass frequencies to the sub woofer or other "LARGE" speaker. However, since bass sounds have a certain amount of directionality it is best not to cut them, if possible. Therefore, even when using small speakers, you can set them to "LARGE" if you want to output the bass frequencies from that speaker. On the other hand, if you are using a large speaker, but prefer not to have bass frequencies output from that speaker, set it to "SMALL." If the overall sound level is lower than you prefer, set all speakers to "LARGE."

Setting the speaker distance

You must set the distance from your listening position to the speakers.
The available distance for a center and a surround speaker depends on that of the front speaker.
The next list shows the selectable distance value of each speaker. The list below describes the available setting for each of speakers. The default adjustments are in parentheses.

Speaker	Distance
FRONT (10 ft/3.0m)	Set this between 3 and 20 ft (0.9 m and 6.0 m) in 1 ft (0.3 m) increments
CENTER (10 ft/3.0m)	Set this between 3 and 20 ft* (0.9 m and 6.0 m) in 1 ft (0.3 m) increments.
SURROUND (10 ft/3.0m)	Set this between 3 and 20 ft* (0.9 m and 6.0 m) in 1 ft (0.3 m) increments.

* The setup value may be different depending on the setup value of the front speaker.

- 1 Press the "▼" SELECT on the Home Menu, then press the "SETUP" SELECT.
The Setup Menu appears.
- 2 Press the "▼" SELECT repeatedly until "SP. DISTANCE" appears.
- 3 Press the "SP. DISTANCE" SELECT.
The Speaker distance setup Menu appears.

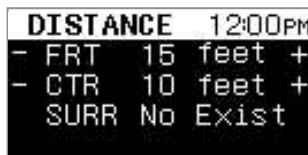

- 4 Select the distance between the Unit and the speaker by pressing the "+" and "-" SELECT.
The distance gets longer or shorter by 1 foot each time you press each of the "+" or "-" SELECT.
"No Exist" appears on the front panel display if you set the size of the speaker to "NONE" in "Selecting a speaker size." (page 44)

Setting a speaker level

The Level Menu contains parameters that let you adjust the balance and speaker volumes of each speaker. The settings available in this menu are applied to all sound fields. Be sure to set "TEST TONE" to "ON" for easy adjustment.
The default adjustments are in parentheses.

Speaker	Speaker level
SUB WOOFER (0 dB)	Set this between -6 dB and +6 dB in 0.5 dB increments.
FRONT (BALANCE)	The balance can be adjusted 8 steps in left and right position.
CENTER (0 dB)	Set this between -6 dB and +6 dB in 0.5 dB increments.
SURROUND L (0 dB)	Set this between -6 dB and +6 dB in 0.5 dB increments.
SURROUND R (0 dB)	Set this between -6 dB and +6 dB in 0.5 dB increments.

- 1 Press the "▼" SELECT on the Home Menu, then press the "SETUP" SELECT.
The Setup Menu appears.
- 2 Press the "▼" SELECT repeatedly until "LEVEL" appears on the front panel display.
- 3 Press the "LEVEL" SELECT.
The Level setup Menu appears.



- 4 Adjust the speaker level by pressing each of the "+," "-", "L," or "R" SELECT.
The SELECT on the left side decrease the level in 0.5 dB steps. For front speaker adjustment, the SELECT on the left side moves the speaker balance toward the left.
The SELECT on the right side increase the level in 0.5 dB steps. For front speaker adjustment, the SELECT on the right side moves the speaker balance toward the right.

Continue to the next page ➞

Settings for Speakers (DVP-NW50 only) (continued)

Adjusting the speaker volume – TEST TONE

The speakers will emit a test tone.
Use the remote while seated in your listening position to adjust the volume of each speaker.
The default setting is underlined.

Test Tone	Function
<u>OFF</u>	The test tone is not emitted from the speakers.
ON	The test tone is emitted from each speaker in sequence while you are adjusting the level. However, when the speaker sizes set to "NONE," the speakers do not emit the test tone.

- 1 Press the "▼" SELECT on the Home Menu, then press the "SETUP" SELECT.
The Setup Menu appears.

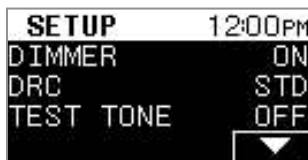

- 2 Press the "TEST TONE" SELECT to activate the TEST TONE.
"ON" and "OFF" are toggled as you press "TEST TONE" SELECT.
You will hear the test tone from each speaker for two seconds each in sequence as follows.
Front speaker (L) → Center speaker → Front speaker (R) → Surround speaker (R) → Surround speaker (L) → Sub woofer
- 3 Adjust the volume level so that the volume of the test tone from each speaker sounds the same when you are in your main listening position.

To adjust	Use
balance of the front right/front left speakers	front balance parameter on the Speaker level Menu (page 45)
volume level of the center/surround/sub woofer	surround balance parameter on the Speaker level Menu (page 45)

- 4 Press the "TEST TONE" SELECT again to turn off the TEST TONE.

Setting the dynamic range compressor

You can compress the dynamic range of the sound track. This may be useful when you want to watch movies at low volumes late at night.
The default setting is underlined.

DRC	Function
<u>OFF</u>	Reproduces the sound track with no compression.
STD	Reproduces the sound track with the dynamic range intended by the recording engineer.
MAX	Provides dramatic compression of the dynamic range.

- 1 Press the "▼" SELECT on the Home Menu, then press "SETUP" SELECT.
The Setup Menu appears.

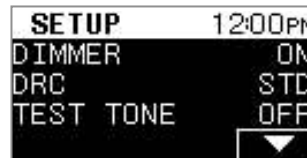

- 2 Press the "DRC" SELECT to activate the Dynamic range compressor.
- 3 Press the "DRC" SELECT again to select the sound. "OFF," "STD," and "MAX" are toggled as you press the button.

Note

Dynamic range compression works with Dolby Digital sources only.

Operating a Sony TV with the Remote

Controlling your TV with the remote

You can operate a Sony TV using the remote without presetting remote codes.

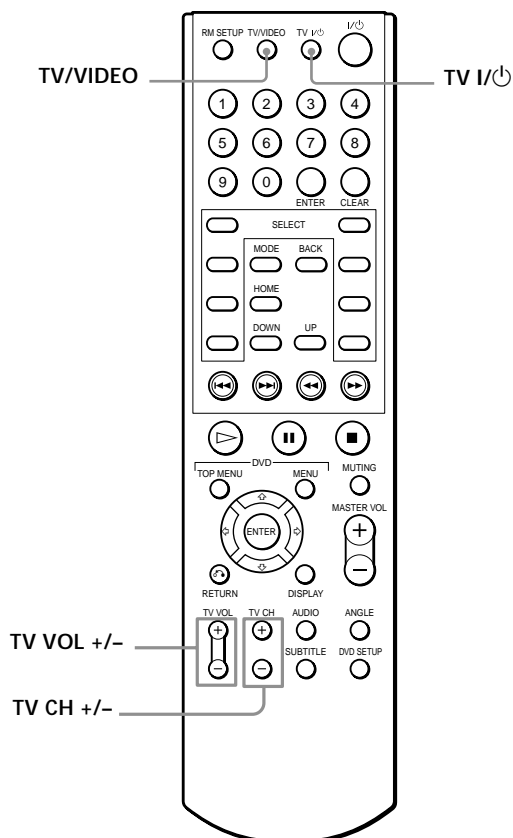

Press TV I/⏻.

Operate your TV using the buttons below.

Buttons	Function
TV I/⏻	Turn the TV on or off
TV/VIDEO	Switch the TV input source between TV and other input sources
TV VOL +/-	Adjust the TV volume
TV CH +/-	Select the TV channel

Note

Depending on the Unit connected, you may not be able to control your TV using some of the buttons above.

Chapter 9

Other Information

This chapter provides you with additional information that will help you understand and maintain your system.

Precautions

On safety

- CAUTION – The use of optional instruments with this product will increase eye hazard.
- To prevent fire or shock hazard, do not place objects filled with liquids, such as vases, on the apparatus.
- Should any solid object or liquid fall into the cabinet, unplug the Unit and have it checked by qualified personnel before operating it any further.
- Unauthorized substitutions may result in fire, electric shock, causing death or serious injury.
Attachment to a wall should not be performed by unqualified persons.
Attachment and adjustment by unqualified persons is dangerous and may cause an accident or cause the unit to fall.
Be sure to consign installation attachment and removal to a qualified service technician.

On power sources

- The Unit is not disconnected from the AC power source as long as it is connected to the wall outlet, even if the Unit itself has been turned off.
- If you are not going to use the Unit for a long time, be sure to disconnect the Unit from the wall outlet. To disconnect the AC power cord, grasp the plug itself; never pull the cord.

On placement

- Place the Unit in a location with adequate ventilation to prevent heat build-up in the Unit.
- Do not place the Unit on a soft surface such as a rug.
- Do not place the Unit in a location near heat sources, or in a place subject to direct sunlight, excessive dust, or mechanical shock.
- Do not install the Unit in an inclined position. It is designed to be operated in a horizontal position only.
- Keep the Unit and the discs away from equipment with strong magnets, such as microwave ovens, or large loudspeakers.
- Do not place heavy objects on the Unit.

On cleaning

Clean the cabinet, panel, and controls with a soft cloth slightly moistened with a mild detergent solution. Do not use any type of abrasive pad, scouring powder or solvent such as alcohol or benzene.

On cleaning discs

Do not use a commercially available cleaning disc. It may cause a malfunction.

IMPORTANT NOTICE

Caution: This Unit is capable of holding a still video image or on-screen display image on your television screen indefinitely. If you leave the still video image or on-screen display image displayed on your TV for an extended period of time, you risk permanent damage to your television screen. Plasma display panel televisions and projection televisions are susceptible to this.

If you have any questions or problems concerning your Unit, please consult your nearest Sony dealer.

Troubleshooting

If you experience any of the following difficulties while using the Unit, use this troubleshooting guide to help you to remedy the problem. Should any problem persist, consult your nearest installer.

Power

The power is not turned on.

- ➔ Check that the AC power cord is connected securely.

Picture

There is no picture.

- ➔ The video connecting cords are not connected securely.
- ➔ The video connecting cords are damaged.
- ➔ The Unit is not connected to the correct TV input jack (page 10).
- ➔ The video input on the TV is not set so that you can view pictures from the Unit.
- ➔ Check the connection to your TV (page 10) and switch the input selector on your TV so that the signal from the Unit appears on the TV screen.

Picture noise appears.

- ➔ The disc is dirty or flawed.
- ➔ If the picture output from your Unit goes through your VCR to get to your TV, the copy-protection signal applied to some DVD programs could affect picture quality. If you still experience problems even when you connect your Unit directly to your TV, try connecting your Unit to your TV's S VIDEO input (page 10).

Even though you set the aspect ratio in "TV Type" of "General Setup," the picture does not fill the screen.

- ➔ The aspect ratio on the disc is fixed.

The picture is not displayed correctly.

The Unit and the TV are not synchronized.

- ➔ Check the "TV Type" setting in "General Setup" (page 28).
(TV in North America uses the NTSC color system).

Continue to the next page ➞

Sound

There is no sound.

- ➔ The speaker cord is not connected securely.
- ➔ Check the speaker settings (Installer's manual).
- ➔ The connecting cord is damaged. Replace it with a new one.
- ➔ Press MUTING on the remote if "MUTING" is displayed on the front panel display.
- ➔ Fast forward or fast reverse is performed. Press ► to return to normal play mode.
- ➔ The Unit input is not correctly set.
- ➔ The Intercom function or the Monitor function is active. Cancel the Intercom function or the Monitor function (page 38, 39).

The left and right sounds are unbalanced or reversed.

- ➔ Check that the speakers and components are connected correctly and securely.
- ➔ Adjust the balance parameter on the Setup Menu (page 43).

There is no sound from the sub woofer.

- ➔ Check the speaker connections and settings (Installer's manual).
- ➔ Make sure that sub woofer is set to "YES" in the speaker setting (page 44).
- ➔ Set the surround mode to "A.F.D" (AUTO FORMAT DIRECT) (page 42).

Severe hum or noise is heard.

- ➔ Check that the speakers and components are connected securely.
- ➔ Check that the connecting cords are away from a transformer or motor, and at least 3 meters (10 feet) away from your TV set or a fluorescent light.
- ➔ Move your TV away from the audio components.
- ➔ The plugs and jacks are dirty. Wipe them with a cloth slightly moistened with alcohol.
- ➔ Clean the disc.

The sound loses stereo effect when you play a VIDEO CD, a CD, or an MP3.

- ➔ Make sure the Unit is connected appropriately.

The surround effect is difficult to hear when you are playing a multi channel source such as Dolby Digital sound track.

- ➔ Check the speaker connections and settings (Installer's manual).
- ➔ Depending on the DVD, the output signal may not be the entire 5.1 channel. It may be monaural or stereo even if the sound track is recorded in Dolby Digital format.

The sound comes from the center speaker only.

- ➔ Depending on the disc, the sound may come from the center speaker only.

No sound is heard from the center speaker.

- ➔ Check the speaker connections and settings.

No sound or only a very low-level sound is heard from the surround speakers.

- ➔ Check the speaker connections and settings.
- ➔ Make sure the rear speakers are set to either "SMALL" or "LARGE" (page 44).
- ➔ Make sure the surround mode function is on (page 42).
- ➔ Depending on the source, the effect of the surround speakers may be less noticeable.
- ➔ The sound volume is low on some DVDs. The sound volume may improve if you set "DRC" on the Setup Menu to "OFF" (page 46).

Network

The Unit cannot detect any other Units nor computers.

- ➔ Network cable is disconnected. Check the network cable connections.
- ➔ An IP address or a Sub-net mask is not set properly. Check the LAN settings on the IP address setup Menu (page 11).
- ➔ A router is turned off. Check the router power condition.

Cannot talk with other room during Intercom.

- ➔ Intercom Privacy is set to on. Set it to off.
- ➔ Connection has not been established. Press the "ANSWER" SELECT (page 38).
- ➔ The volume level is low. Press +VOLUME to adjust the volume.
- ➔ Other Units have been using Intercom. Wait for a while until Intercom is available.

Cannot monitor other rooms.

- ➔ Monitor Privacy is set to on. Set it to off.
- ➔ The volume level is low. Press +VOLUME to adjust the volume.
- ➔ Other Units have been using Intercom. Wait for a while until Monitor is available.

Cannot get track title while listening to music from NETWORK or MY MUSIC.

- ➔ The PC application is not running. Start the PC application on your computer.

Audio reception is interrupted or distorted.

- ➔ The network does not have enough bandwidth. Check to see if the network cable supports 100BASE-TX or not.
- ➔ The network cable, network switch, or router device may not support 100BASE-TX. Check to see if the router device supports 100BASE-TX or not.

Operation**The remote does not function.**

- ➔ The batteries in the remote are weak.
- ➔ There are obstacles between the remote and the Unit.
- ➔ The distance between the remote and the Unit is too far.
- ➔ The remote is not pointed at the remote sensor on the Unit.
- ➔ The remote code switch setting on the remote does not match the setting on the Unit.

Radio stations cannot be tuned in.

- ➔ Check that the antennas are connected securely. Adjust the antennas or connect an external antenna if necessary.
- ➔ The signal strength of the stations is too weak (when tuning in with automatic tuning). Use direct tuning.
- ➔ No stations have been preset or the preset stations have been cleared (when tuning by scanning preset stations). Preset the stations (page 31).

The remote does not function.

- ➔ There are obstacles between the remote and the Unit.
- ➔ The distance between the remote and the Unit is too far.
- ➔ The remote is not pointed at the remote sensor on the Unit.
- ➔ The batteries in the remote are weak.

The disc does not play.

- ➔ There is no disc inserted.
- ➔ The disc is upside down.
Insert the disc with the playback side facing the Unit.
- ➔ The disc is skewed.
- ➔ The Unit cannot play certain discs (page 8).
- ➔ The region code on the DVD does not match the Unit.
- ➔ Moisture has condensed inside the Unit.
Remove the disc and leave the Unit turned on for about half an hour.

The MP3 audio track cannot be played.

- ➔ The DATA CD is not recorded in an MP3 format that conforms to ISO 9660 Level 1/Level 2 or Joliet.
- ➔ The MP3 audio track does not have the extension “.MP3.”
- ➔ The data is not formatted in MP3 even though it has the extension “.MP3.”
- ➔ The Unit can only play MP3 (MPEG1 Audio Layer3) audio.
- ➔ The Unit cannot play audio tracks in MP3PRO format.

The disc does not start playing from the beginning.

- ➔ Shuffle Play, or Repeat Play has been selected (page 21, 23, 24).
Cancel Shuffle Play, or Repeat Play (page 21, 23, 24).
- ➔ Resume Play has been selected.
During stop, press ■ on the remote and then start playback (page 22, 23).
- ➔ The title, DVD or PBC menu automatically appears on the TV screen.

Playback stops automatically.

- ➔ Some discs may contain an auto pause signal.
While playing such a disc, the Unit stops playback at the auto pause signal.

The Unit turns off during DVD playback.

- ➔ The Sleep Timer turned off the Unit at the preset time (page 41).

Some functions such as Stop, Search, Repeat Play, or Shuffle Play cannot be performed.

- ➔ Depending on the disc, you may not be able to perform some of the operations above. See the operating manual that came with the disc.

Continue to the next page ➞

The language for the sound track cannot be changed.

- ➔ Multilingual tracks are not recorded on the DVD being played.
- ➔ The DVD prohibits changing the language for the sound track.

The subtitle language cannot be changed.

- ➔ Multilingual subtitles are not recorded on the DVD being played.
- ➔ The DVD prohibits changing subtitles.

The subtitle cannot be turned off.

- ➔ The DVD prohibits turning off subtitles.

The angles cannot be changed.

- ➔ Multi-angles are not recorded on the DVD being played (page 29).
- ➔ The DVD prohibits changing angles.

A disc cannot be ejected and "LOCKED" appears on the front panel display.

- ➔ Contact your Sony dealer or local authorized Sony service facility.

"PROTECT" appears on the front panel display.

- ➔ The speaker protection circuit is functioning.
- ➔ Check the speaker connections.

The Unit does not work normally.

- ➔ If the Unit's operation becomes effected, press I/⏻ (POWER) on the Unit to turn off the power, then turn on the power again.

Error Messages

If any of the messages below appear on the front panel display of the Unit, check the following table to solve the problem. If any problem persists, consult your nearest Sony dealer.

Category	Message	Cause	Corrective action
	PROTECTOR	Circuit protector is working	Irregular current is output from speakers. Turn off the power and check the speaker connections, then turn on the power again.
CD/DVD	NO DISC	A disc is not inserted or correspondent to the Unit.	Insert a disc that is correspondent to the Unit.
NETWORK/ MY MUSIC	IN USE BY xxx	xxx is using the disc in the specific Unit. xxx is the name of the Unit.	Turn off the Main Unit and check the speaker hookup.
	Access inhibit	Party Privacy is set to ON on the specific Unit.	Quit Party Privacy.
INTERCOM	Access inhibit	Intercom Privacy is set to ON on the specific Unit.	Quit Intercom Privacy.
MONITOR	Access inhibit	Monitor Privacy is set to ON on the specific Unit.	Quit Monitor Privacy.
Other	Invalid	Cannot use a specific key on the remote or enter the Party mode.	This operation is not currently enabled.

Specifications

CDP-NW10/DVP-NW50

Laser	Semiconductor laser (CD: $\lambda = 780\text{nm}$) (DVD: $\lambda = 650\text{nm}$) Emission duration: continuous
Signal format system	NTSC
Audio section	
Frequency response	20 Hz to 20 kHz (± 1 dB)
Signal-to-noise ratio	95 dB
Rated output power 1kHz into 8ohms THD: 3%	CDP-NW10: 30 W + 30 W DVP-NW50: 50 W + 50 W
Input sensitivity (LINE IN)	500 mVrms
Harmonic distortion	Less than 0.1 %
Wow and flutter	Less than detected value (± 0.001 % W PEAK)
Tuner section	
Frequency range	87.5 Hz to 108 kHz (100kHz step) 530 kHz to 1710 kHz (10kHz step)
Signal-to-noise ratio	54 dB 76 dB (MONO) 70 dB (STEREO)
THD at 400Hz	0.5 %
THD at 1kHz	0.3 % (MONO) 0.5 % (STEREO)
Antenna (aerial)	FM wire antenna (aerial)
Antenna (aerial) terminals	75 ohms, unbalanced
Intermediate frequency	10.7 MHz
AM tuner section	
Antenna (aerial)	AM loop antenna (aerial)
Intermediate frequency	450 kHz

Video section (DVP-NW50 only)

Composite video out:	1Vp-p 75ohms
S1 video out:	Y: 1Vp-p 75ohms C: 0.286 Vp-p 75ohms

General

DC power consumption:

CDP-NW10: DC 29.5 V/1A DC 14V/1.5A
DVP-NW50: DC 29.5 V/1A DC 29.5 V/1A DC 14V/1.5A

Power consumption: 540 W

Operating temperature: 0°C to 40°C (-32°F to 104°F)

Dimensions: 230 × 266 × 104 mm
(9 1/8 × 10 1/2 × 4 1/8 inches)
(w/h/d)

Mass: CDP-NW10: 2.5 kg (5 lbs 8 oz)
DVP-NW50: 2.7 kg (5 lbs 15 oz)

Supplied accessories : For details on this see "Installer's manual"

Design and specifications are subject to change without notice.

Language Code List

Code	Language
6565	Afar
6566	Abkhazian
6570	Afrikaans
6577	Amharic
6582	Arabic
6583	Assamese
6588	Aymara
6590	Azerbaijani
6665	Bashkir
6669	Byelorussian
6671	Bulgarian
6672	Bislama
6678	Bengali
6679	Tibetan
6682	Breton
6765	Catalan
6779	Corsican
6783	Czech
6789	Welsh
6865	Danish
6869	German
6890	Bhutani
6976	Greek
6978	English
6979	Esperanto
6983	Spanish
6984	Estonian
6985	Basque
7065	Persian
7073	Finnish
7074	Fiji
7079	Faeroese
7082	French
7089	Frisian
7165	Irish
7168	Scots/Gaelic
7176	Galician
7178	Guarani
7185	Gujarati
7265	Hausa
7273	Hindi
7282	Croatian

Code	Language
7285	Hungarian
7289	Armenian
7365	Interlingua
7378	Indonesian
7383	Icelandic
7384	Italian
7387	Hebrew
7465	Japanese
7473	Yiddish
7487	Javanese
7565	Georgian
7575	Kazakh
7576	Greenlandic
7577	Cambodian
7578	Kannada
7579	Korean
7583	Kashmiri
7585	Kurdish
7589	Kirghiz
7665	Latin
7678	Lingala
7679	Laothian
7684	Lithuanian
7686	Latvian/Lettish
7771	Malagasy
7773	Maon
7775	Macedonian
7776	Malayalam
7778	Mongolian
7779	Moldavian
7782	Marathi
7783	Malay
7784	Maltese
7789	Burmese
7865	Nauru
7869	Nepali
7876	Dutch
7879	Norwegian
7982	Oriya
8065	Punjabi
8076	Polish
8083	Pashto/Pushto

Code	Language
8084	Portuguese
8185	Quechua
8277	Rhaeta-Romance
8279	Romanian
8285	Russian
8365	Kinyarwanda
8368	Sanskrit
8372	Serbo-Croatian
8373	Singhalese
8375	Slovak
8376	Slovenian
8377	Samoan
8378	Shona
8379	Somali
8381	Albanian
8382	Serbian
8385	Sundanese
8386	Swedish
8387	Swahili
8465	Tamil
8469	Tegulu
8471	Tajik
8472	Thai
8473	Tigrinya
8475	Turkmen
8476	Tagalog
8479	Tonga
8482	Turkish
8484	Tatar
8487	Twi
8575	Ukrainian
8582	Urdu
8590	Uzbek
8673	Vietnamese
8679	Volapuk
8779	Wolof
8872	Xhosa
8979	Yoruba
9072	Chinese
9085	Zulu

Index

Numerics

- 16:9 Wide 29
- 2CH STEREO 42

A

- A.F.D 42
- ALARM 40
- ANGLE 17, 26
- Angle Mark 29
- AUDIO 17, 26
- Audio 29

B

- BACK 15, 17
- BALANCE 43, 45
- Batteries 18

C

- Cable connect 10
- Call sound 38
- Captions 29
- CD 5, 20, 22
- CHAPTER 26
- CLEAR 17
- Component 34

D

- DATA CD 5
- Default 30
- DIAGNOSIS 12
- DIMMER 43
- Disc Menu 29
- DISPLAY 17, 26
- DOLBY PL 42
- DOLBY PLII 42
- DOWN/UP 17
- DRC 46
- DVD 5, 23
- DVD SETUP 17
- Dynamic range 46

E

- ENTER 17

F

- Fast forward 25
- Fast reverse 25

H

- HOME 17

I

- INTERCOM 38
- INTERCOM PRIVACY 38
- IP ADDRESS 11
- IR ROUTE 11

L

- Language code list 55
- LEVEL 45
- LINE IN 34

M

- MASTER VOL 17
- MENU 17
- MODE 15, 17
- MONITOR 39
- MONITOR PRIVACY 39
- MP3 25
- MUTING 15, 17
- MY MUSIC 36

N

- NAME 12
- NETWORK 35
- Normal/LB 29
- Normal/PS 29
- Numeral Buttons 17

O

- OPEN/CLOSE 15
- OSD Lang 29

P

- Parental 29
- Parental Control 27
- Party Join 37
- Party mode 37
- PARTY PRIVACY 37
- Password 29
- PBC Playback 24
- Play Mode 21, 23, 36
- Preset station 33

R

- Radio 31
- Remote 11, 16, 18, 47
- Remote code 13
- Repeat Play 21, 23, 24, 36
- RESET 30
- Resume Play 23
- RETURN 17
- RM SETUP 17, 18

S

- Scan 21, 25
- Screen Saver 29
- Search 21, 25
- SELECT 15, 17, 18
- Setup Display 28
- Shuffle Play 21, 23, 36
- SIRCS 13
- SLEEP 41
- Sleep timer 41
- SPEAKER DISTANCE 45
- SPEAKER SIZE 44
- SUBTITLE 17, 26
- Subtitle 29
- Surround mode 42

T

TEST TONE	46
TIME OUT	13
TITLE	26
TOP MENU	17
TRACK	26
Troubleshooting	49
TUNER	31
TV	47
TV CH	17, 47
TV Type	28
TV/VIDEO	17, 47
TV VOL	17, 47
TV I/⏻	17, 47

U

Unit Name	12
-----------	----

V

VIDEO CD	5, 24
VOL PRESET	43
VOLUME	15, 17, 38, 39

Symbols

I/⏻	15, 17
◀◀/▶▶	17
⏮/⏭	15, 17
⏸(PAUSE)	15, 17
▶(PLAY)	15, 17
↓/↑(SCROLL DOWN/UP)	15
↻/↺/↻/↻	17
■ (STOP)	15, 17

